

SLING AREA/SITE



SLING AREA/SITE

EXO's Sling area/site family is available in two sizes as well as a variety of outputs allowing you to customize your lighting design to meet application requirements. With a new spin on a classic form, Sling brings the traditional cobra head aesthetic into the next generation of LED lighting. Sling features a dense optical array which provides reduced pixilation and increased visual comfort without compromising performance. Designed for sustained, long-term performance with advanced thermal management, an elegantly simple heat sink and industry leading surge protection.



Size	Sling Area/Site (ASL1)	Sling Area/Site (ASL1)	Sling Area/Site (ASL2)
Lumens	3,000–6,000	9,000–18,000	21,000–36,000
Watts	25–50W	70–135W	145–255W
LPW	140	143	148
Mounting	Mast Arm, Wall	Mast Arm, Wall	Mast Arm, Wall
CCT	3K, 4K, 5K	3K, 4K, 5K	3K, 4K, 5K
Distributions	2, 3, 4F, 4W, 5QW	2, 3, 4F, 4W, 5QW	2, 3, 4F, 4W, 5QW
Surge Protection	20kA	20kA	20kA
Legacy Equivalence	100–175W	175–400W	400–1000W

SLING AREA/SITE PERFORMANCE

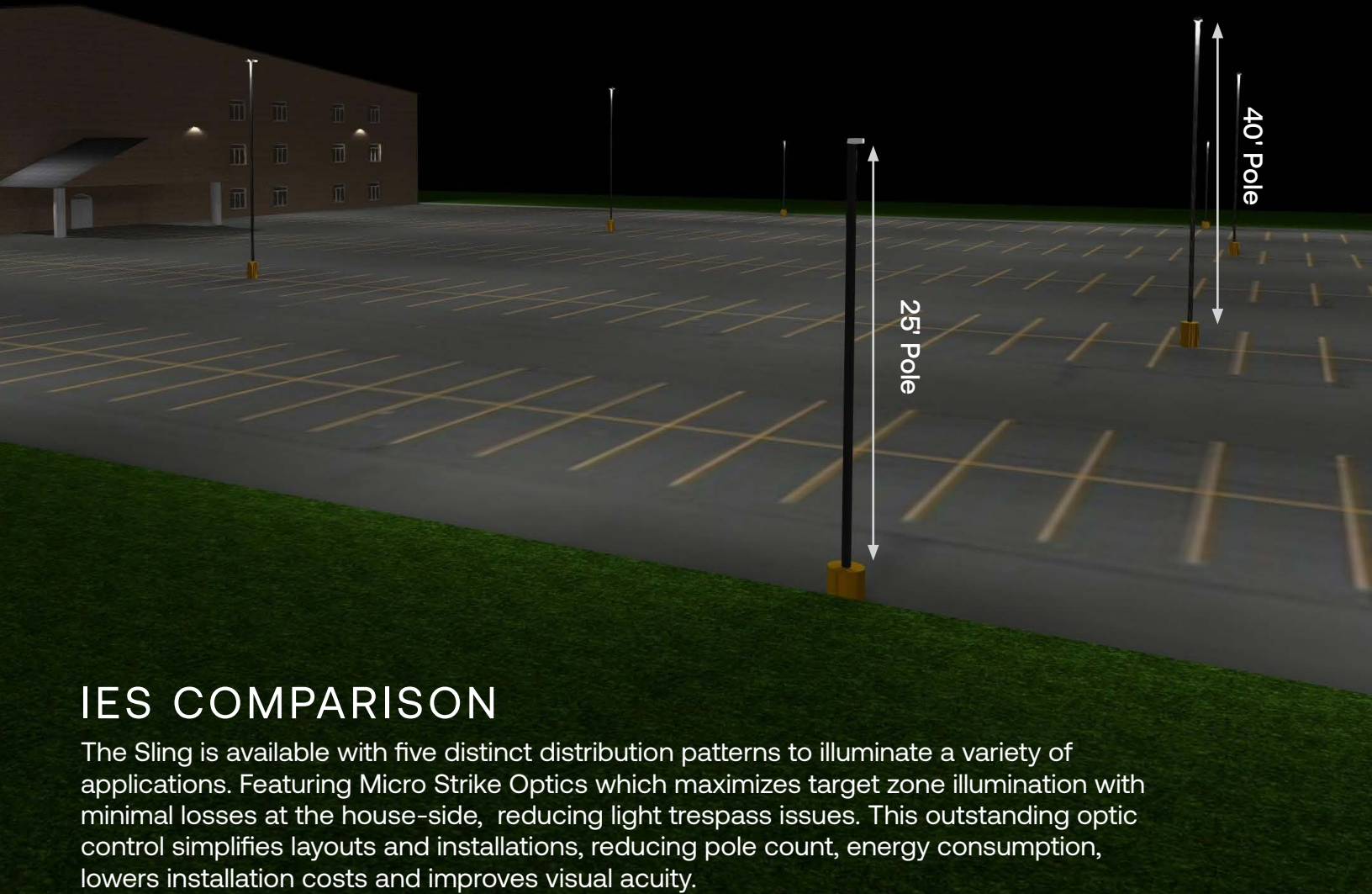

IES COMPARISON

The Sling is available with five distinct distribution patterns to illuminate a variety of applications. Featuring Micro Strike Optics which maximizes target zone illumination with minimal losses at the house-side, reducing light trespass issues. This outstanding optic control simplifies layouts and installations, reducing pole count, energy consumption, lowers installation costs and improves visual acuity.

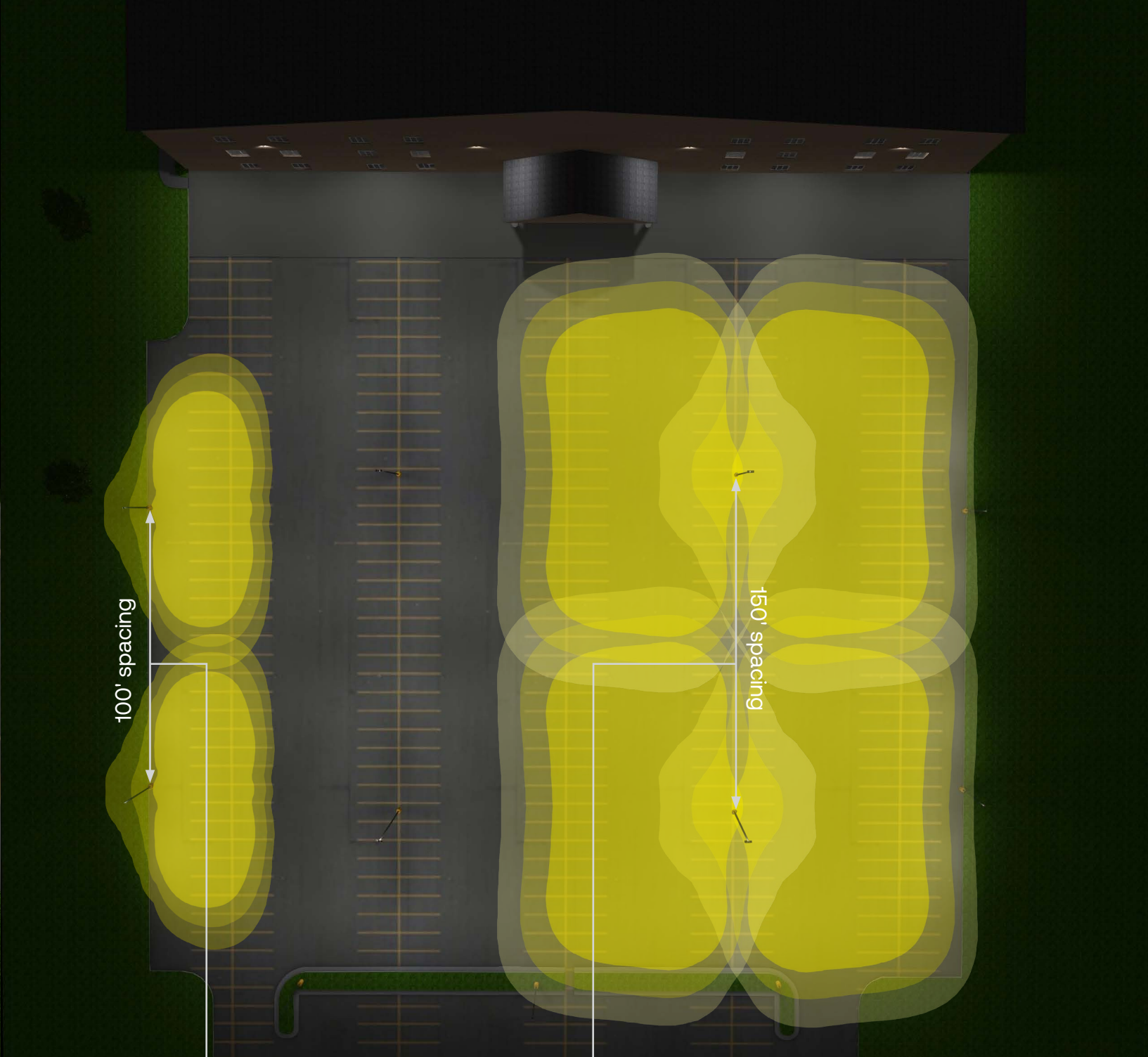
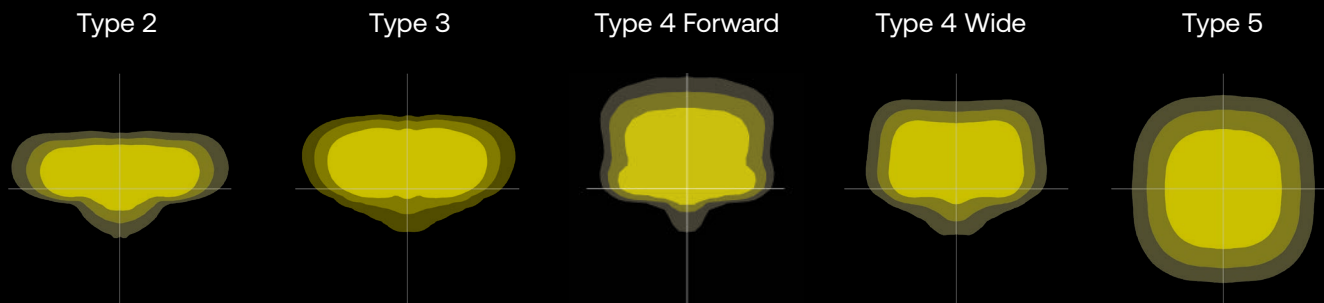

The 135W Sling replaces 400W legacy luminaires and can be seen here on 25ft poles. The Type III distribution provides great spacing between poles and minimal backlight.

The 255W Sling replaces 1000W legacy luminaires on up to 40ft poles. The Type IV distribution enhances uniformity by pushing light to the corners of the distribution where dark spots are most common.

SLING AREA/SITE

INTEGRATED CONTROLS

Controls in area/site applications save energy, extend luminaire life and allow customizable solutions. Sensors control light output based on area utilization and are used for energy savings and local code compliance.



Occupancy Sensor

- Individual fixture control
- Dims product when space is not occupied



7-Pin Receptacle

- Compatible with 3-pin, 5-pin or 7-pin photocontrols
- Turns fixture on when sun sets, off when sun rises
- Wireless networked solution *
- For use with a variety of control platforms

*Additional accessories required.



SLING AREA/SITE

ORDERING

ORDERING EXAMPLE: ASL1-80L-50-4K7-2-L-UNV-ASQ-BLT

Series	# LEDs	CCT/CRI	Distribution	Rotation/Orientation	Voltage	Mounting
ASL1 ASL Microstrike Series	80L-25 3,000 lm	3K7 3000K, 70 CRI	2 Type II	L Optic rotation left	UNV Universal 120-277V	A Arm Square w/ Mounting Block
	80L-39 4,500 lm	4K7 4000K, 70 CRI	3 Type III	R Optic rotation right		
	80L-50 6,000 lm	5K7 5000K, 70 CRI	4F Type 4F			
	160L-70 9,000 lm		4W Type 4W			
	160L-100 12,000 lm		5QW Type 5QW			
	160L-115 15,000 lm					
ASL2 ASL Microstrike Series	160L-135 18,000 lm				120 120V	A3 AS with 3.5-4.13" OD RPA3 & UM
	320L-145 21,000 lm				208 208V	A4 AS with 4.18-5.25" OD RPA4 & U
	320L-170 24,000 lm				240 240V	A5 AS with 5.5-6.5" OD RPA5 & UM
	320L-185 27,000 lm				277 277V	MAF Mast Arm Fitter for 2-3/8" OD
	320L-210 30,000 lm				347 347V	
	320L-235 33,000 lm				480 480V	

Control Options	Options	Color
7PR 7 Pin Receptacle	F Fusing	BLT Black Matte Textured
7PR-SC 7 Pin Receptacle with shorting cap	BC Backlight Control	BLS Black Gloss Smooth
7PR-MD8F 7 pin receptacle with low voltage sensor at 8' mounting for external control accessory	TB ² Terminal Block	DBT Dark Bronze Matte Textured
7PR-MD40F 7 pin receptacle with low voltage sensor at 40' mounting for external control accessory	TE Toolless Entry	DBS Dark Bronze Gloss Smooth
7PR-TL 7 Pin Receptacle with Photocontrol	SSF Stainless Steel Fasteners	GTT Graphite Matte Textured
Sensors		LGS Light Grey Gloss Smooth
BTS_F Bluetooth Programmable, PIR Occupancy/Daylight Sensors, 360° lens ³		LGT Light Grey Matte Textured
BTSO_F Bluetooth Programmable, PIR Occupancy/Daylight Sensor, 360° lens, up to 12' mounting height ⁴		PSS Platinum Silver Smooth
		WHT White Matte Textured
		WHS White Gloss Smooth
		VGT Verde Green Textured
		Color Option
		CC Custom Color

- Notes:
- 1 Must specify voltage
 - 2 Not available with a combination or 347/480 and fusing
 - 3 Replace " _ " with "14" for up to 14' mounting height, "40F" for 15-40' mounting height
 - 4 Replace " _ " with "12" for up to 12' mounting height

 = Available in QuickShip Service Program

DIMENSIONS

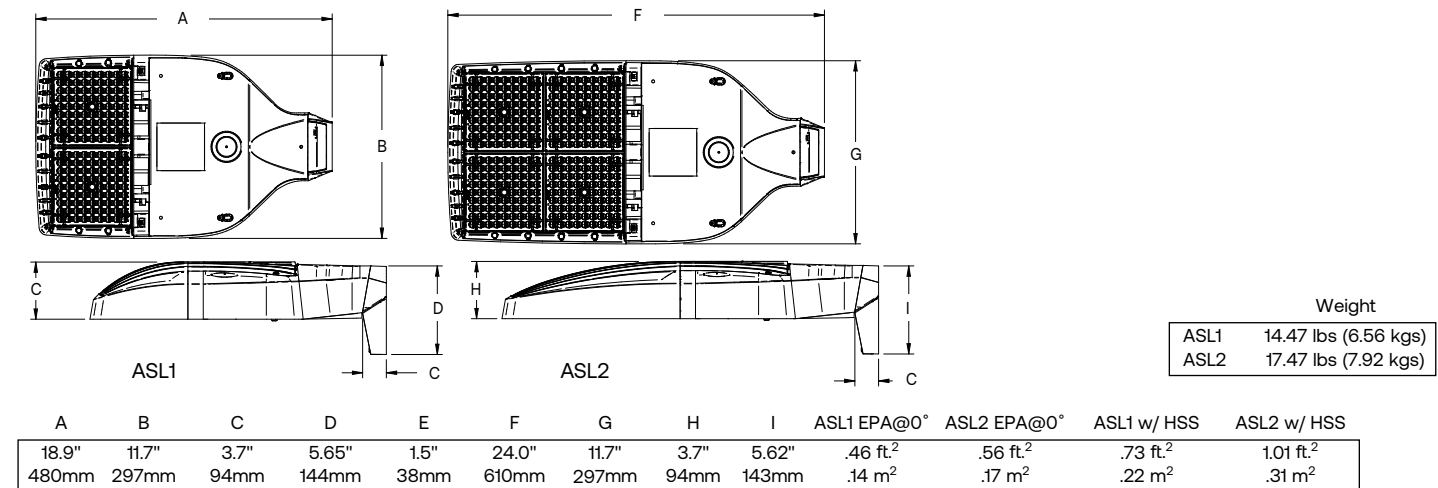

ACCESSORIES (Order Separately)

Catalog Number	Description
ASL1-HSS-90-B-XXX ¹	House Side Shield Back 90 deg
ASL1-HSS-90-F-XXX ¹	House Side Shield Front 90 deg
ASL1-HSS-90-S-XXX ¹	House Side Shield Side 90 deg
ASL1-HSS-270-BSS-XXX ¹	House Side Shield Back, Side & Side 270 deg
ASL1-HSS-270-FSS-XXX ¹	House Side Shield Front, Side & Side 270 deg
ASL1-HSS-270-FSB-XXX ¹	House Side Shield Front, Side & Back 270 deg
ASL1-HSS-360-XXX ¹	House Side Shield 360 deg
ASL2-HSS-90-B-XXX ¹	House Side Shield Back 90 deg
ASL2-HSS-90-F-XXX ¹	House Side Shield Front 90 deg
ASL2-HSS-90-S-XXX ¹	House Side Shield Side 90 deg
ASL2-HSS-270-BSS-XXX ¹	House Side Shield Back, Side & Side 270 deg
ASL2-HSS-270-FSS-XXX ¹	House Side Shield Front, Side & Side 270 deg
ASL2-HSS-270-FSB-XXX ¹	House Side Shield Front, Side & Back 270 deg
ASL2-HSS-360-XXX ¹	House Side Shield 360 deg
ASL-MAF	Mast arm kit with wildlife shield for mounting on 2 3/8" OD arms
SETA2-XX ¹	Square pole tenon adapter (4 at 90 degrees) (2 3/8" OD tenon)
RETA2-XX ¹	Round pole tenon adapter (4 at 90 degrees) (2 3/8" OD tenon), requires CLIS-RPA4-ACC-XX for each luminaire
RARBC80L	Backlight Control 80L
RARBC160L	Backlight Control 160L
RARBC320L	Backlight Control 320L
RARBC480L	Backlight Control 480L
CLIS-RPA4-ACC-XX ¹	Round Pole Adapter (* denotes pole diameter; 3 = 3 1/4" - 3 3/4"; 4* = 3 7/8" - 6")
ASL-ARMTG-XX ¹	Arm mounting kit for side of pole attachment
WB-AREA-XX ¹	Wall bracket, Compatible with standard arm mount option
ASL-MAF	Mast arm kit with wildlife shield for mounting on 2 3/8" OD arms

CONTROL ACCESSORIES

Catalog Number	Description
	Notes:
	* When ordering SiteSync at least one of these two interface options must be ordered per project
	+ Available as a SiteSync retrofit solution for fixtures with an existing 7pin receptacle
	1 Replace XX or XXX with color choice, eg: DB for Dark Bronze or BLT for Black Matte Textured

MOUNTING

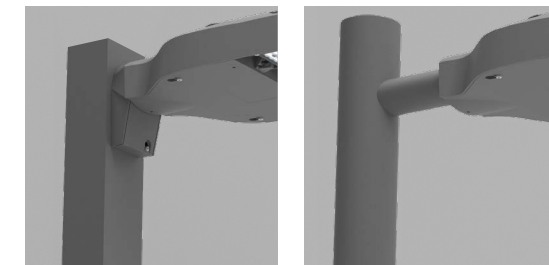

Arm Mount – Fixture ships with integral arm for ease of installation. Compatible with S2 drill pattern.

MAF – Fits 2-3/8" OD arms Roadway applications.









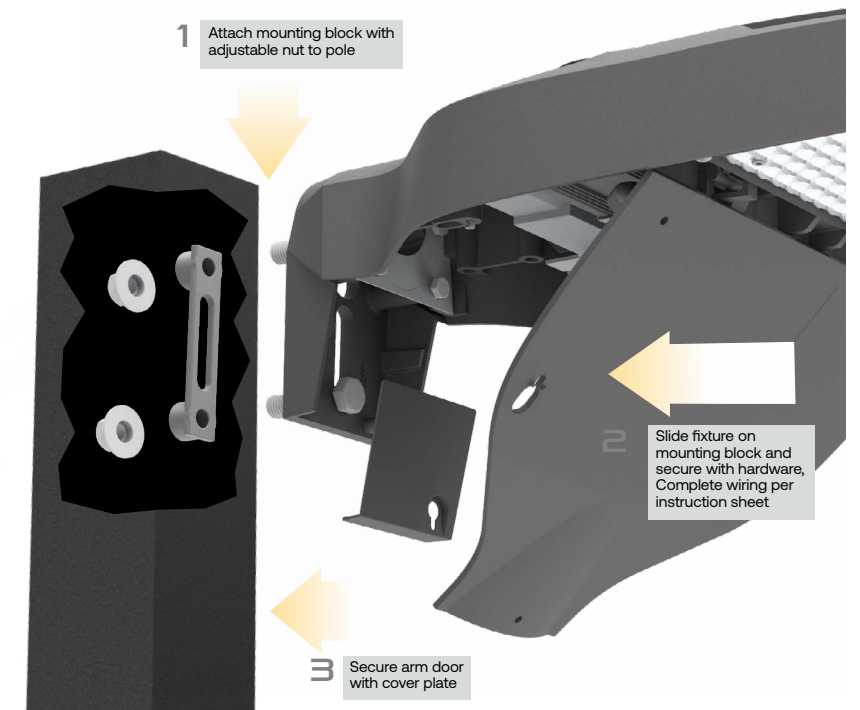

Wall Mount – Wall mount bracket designed for building mount applications.

SQUARE ARM MOUNTING BLOCK

Mounting block for ease of installation. Compatible with drill patterns from 2.5" to 4.5"

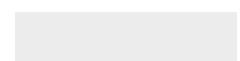
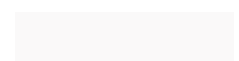
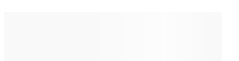

FINISH OPTIONS

 BLT Black Matte Textured	 BLS Black Gloss Smooth	 DBT Dark Bronze Matte Textured	 DBS Dark Bronze Gloss Smooth	 GTT Graphite Matte Textured	 PSS Platinum Silver Smooth
 LGT Light Grey Gloss Smooth	 LGS Light Grey Gloss Smooth	 WHT White Matte Textured	 WHS White Gloss Smooth	 VGT Verde Green Textured	

SLING AREA/SITE

Luminaire / Pole Combination STOCK SHIPMENT PROGRAM



PRONTO COMBO

STOCK

SLING Series Luminaire

- Compact sleek design with multiple configurations and simple installation
- Single & Double 180 deg. Configurations 4000K CCT (70 CRI)
- Type 3 & 4W Distributions
- Dark Bronze Powder Paint (textured)

SSS Series Poles

- Square Straight Steel Construction
- 4" Square x 0.125" Wall Thickness
- 20' & 25' Lengths
- Pole Base Accommodates 8"-10" Bolt Circles using Four (4) 3/4" Diameter Anchor Bolts
- Dark Bronze Powder Paint (textured)
- Optional Vibration Damper Available as Accessory



Quick Shipments

- All Product Manufactured and Ship From Christiansburg, VA
- Consolidated Shipment – Everything Arrives On One Truck!
- All Configurations Available Less Anchor Bolts
- Stocked Anchor Bolts & Templates Available for Advanced Foundation Construction

Complete Fixture, Pole, Anchor Bolts/Base Covers, Pole Caps and Template



Ordering Information – Pole Combo

Catalog Number	Pole	Single or Double Head	Fixture	Distribution
ASL1-100-4K7-3-S20	20' Square Straight Steel	Single Head	ASL-160L-100-4K7	3
ASL1-100-4K7-4W-S20	20' Square Straight Steel	Single Head	ASL-160L-100-4K7	4W
ASL1-100-4K7-3-S20-2X	20' Square Straight Steel	Double Head (180°)	ASL-160L-100-4K7	3
ASL1-100-4K7-4W-S20-2X	20' Square Straight Steel	Double Head (180°)	ASL-160L-100-4K7	4W
ASL1-100-4K7-3-S25	25' Square Straight Steel	Single Head	ASL-160L-100-4K7	3
ASL1-100-4K7-4W-S25	25' Square Straight Steel	Single Head	ASL-160L-100-4K7	4W
ASL1-100-4K7-3-S25-2X	25' Square Straight Steel	Double Head (180°)	ASL-160L-100-4K7	3
ASL1-100-4K7-4W-S25-2X	25' Square Straight Steel	Double Head (180°)	ASL-160L-100-4K7	4W
ASL1-135-4K7-3-S20	20' Square Straight Steel	Single Head	ASL-160L-135-4K7	3
ASL1-135-4K7-4W-S20	20' Square Straight Steel	Single Head	ASL-160L-135-4K7	4W
ASL1-135-4K7-3-S20-2X	20' Square Straight Steel	Double Head (180°)	ASL-160L-135-4K7	3
ASL1-135-4K7-4W-S20-2X	20' Square Straight Steel	Double Head (180°)	ASL-160L-135-4K7	4W
ASL1-135-4K7-3-S25	25' Square Straight Steel	Single Head	ASL-160L-135-4K7	3
ASL1-135-4K7-4W-S25	25' Square Straight Steel	Single Head	ASL-160L-135-4K7	4W
ASL1-135-4K7-3-S25-2X	25' Square Straight Steel	Double Head (180°)	ASL-160L-135-4K7	3
ASL1-135-4K7-4W-S25-2X	25' Square Straight Steel	Double Head (180°)	ASL-160L-135-4K7	4W

Quick Ship Ordering Information – Standalone Fixture

Series	# LEDs	CCT/CRI	Distribution	Rotation/Orientation	Mounting	Voltage	Color
ASL1 Sling 1 Microstrike Series	160L-115	15,000 lm	4K7 4000K, 70 CRI	L Optic rotation left R Optic rotation right	A Arm Square w/ S2 Drill Pattern	UNV Universal 120-277V	BLT Black Matte Textured DBT Dark Bronze Matete Textured
	160L-135	18,000 lm					
	320L-145	21,000 lm					
ASL2 Sling 2 Microstrike Series			3 Type III 4W Type 4W 5QW Type 5QW				



Current Lighting Solutions, LLC

701 Millennium Blvd.
Greenville, SC 29607

www.currentlighting.com/exo

© 2022 HLI Solutions, a division of Current, Inc. All rights reserved. Information and specifications subject to change without notice
All values are design or typical values when measured under laboratory conditions.

Rev 03/24/2023

AIRO_Micro Strike brochure HOL_R01
