



Luminaires provide a balance of visual comfort and performance in two sleek low profile housing sizes. A wide range of lumen outputs and distributions paired with a specially designed lens makes Drive Edge-Lit luminaires the ideal solution for parking garage and canopy applications.

TWO SIZES AND MULTIPLE OUTPUTS

Drive Edge-Lit luminaires are available in two sizes. The compact SRT1 provides 2,500–6,000 lumens while the SRT2 offers an output range of 4,000–16,000 lumens.

PHOTOMETRIC PERFORMANCE

Available in four distribution patterns for maximum luminaire spacing, design flexibility and energy savings. Drive Edge-Lit luminaires deliver uniform illumination that meets or exceeds IES recommended requirements for drive lanes, parking areas, stairwells, entrances and exits.

INTEGRATED CONTROLS

A broad offering of control solutions are available ranging from standalone sensors, NX Lighting Controls and wiSCAPE® wireless controls.



SRT1

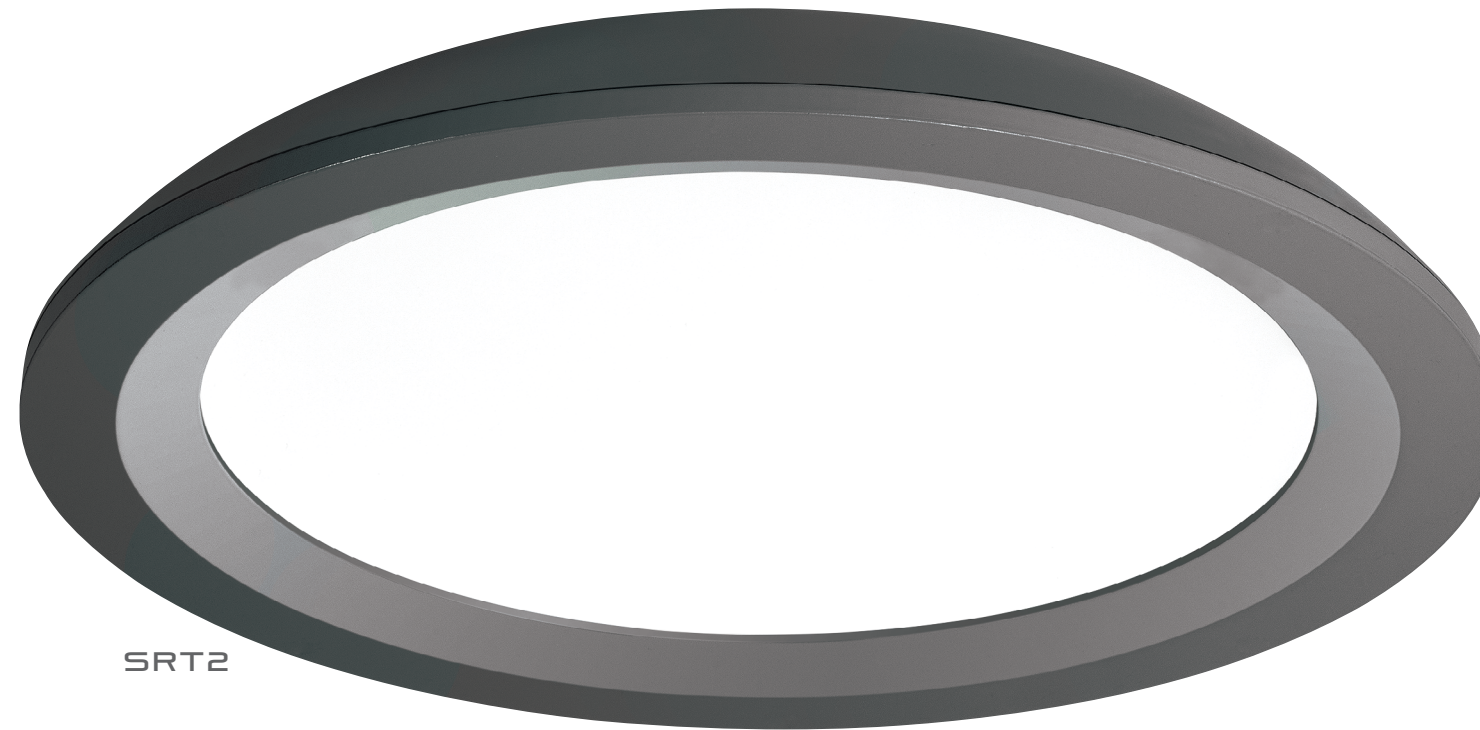

SRT2

UPLIGHT

Optional uplight available on both SRT1 and SRT2, delivering 800 lumens to eliminate unwanted cave appearance.

VISUAL COMFORT

A specially designed acrylic light guide provides a blended, non-pixelated distribution over the entire surface area of the lens for visual comfort and glare reduction.

SURGE SUPPRESSION

Standard 10kV surge suppression provides an enhanced level of protection against power spikes and surges for piece of mind and long term operation.

EMERGENCY SOLUTIONS

SRT2 is available with integral battery backup as well as a dimming transfer device for standalone and wireless control override during power interruptions.

EASE OF INSTALLATION

A standard quick mounting bracket allows for quick and easy installation. The mounting plate can be installed prior to luminaire to simplify and maximize labor savings.



PHOTOMETRIC PERFORMANCE

Parking garages require scalability as well as a wide variety of distributions to meet specific application requirements. The SRT1 is available in two distribution types: Type 5 Square Wide and Type 5 Concentrated ideal for typical parking garage and canopy applications. For increased flexibility, the SRT2 offers two additional distributions (four total) including the Type 5 Square Wide, Type 5 Concentrated, Type 5 Rectangular Wide and an Asymmetric (Type 4).

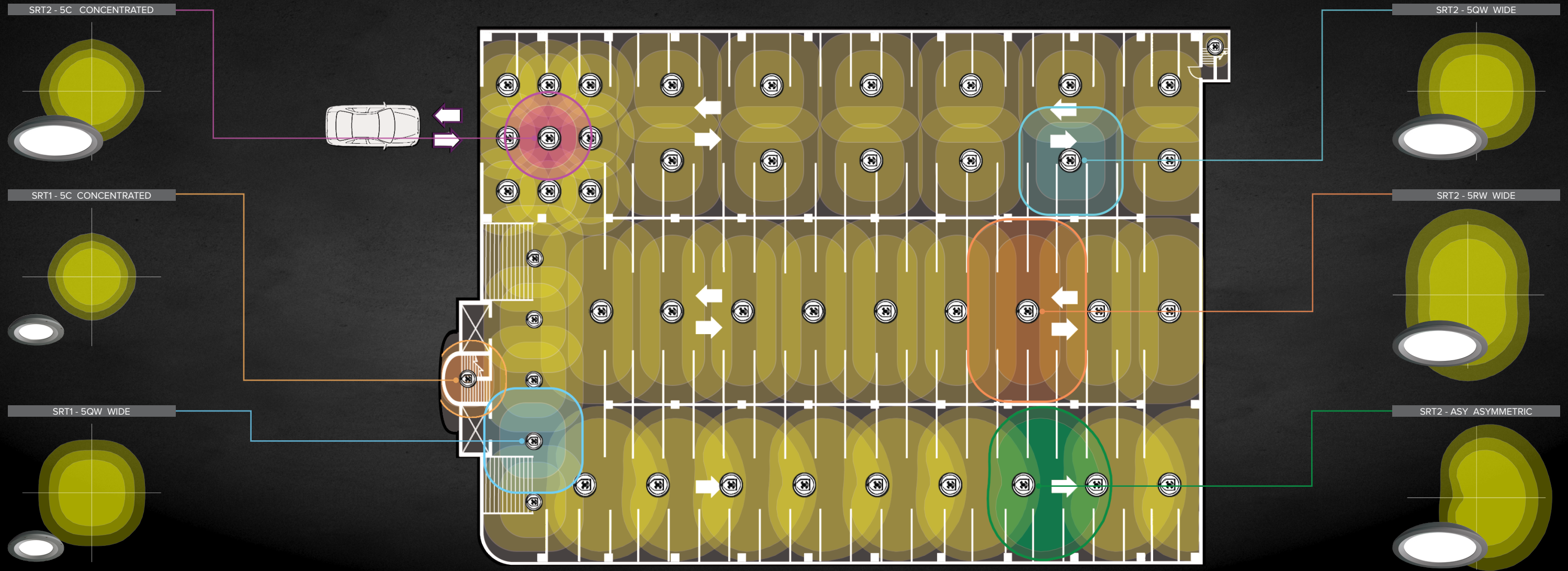

ENTRANCE

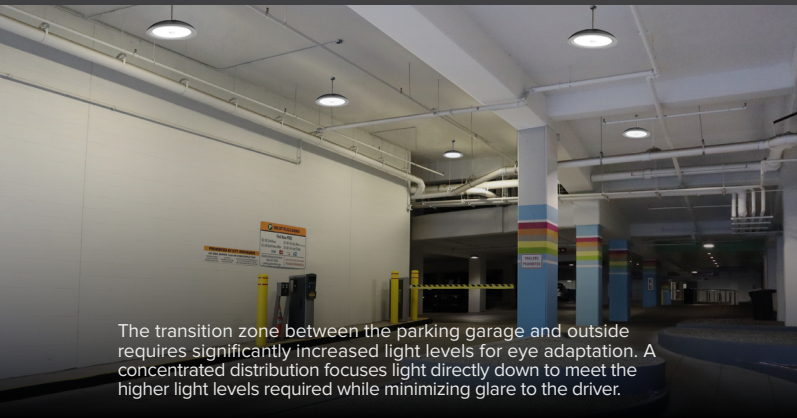

The transition zone between the parking garage and outside requires significantly increased light levels for eye adaptation. A concentrated distribution focuses light directly down to meet the higher light levels required while minimizing glare to the driver.

STAIRWELLS/EXITS

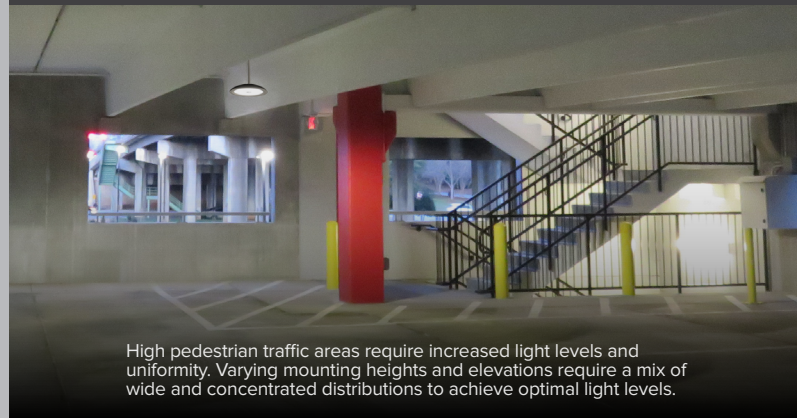

High pedestrian traffic areas require increased light levels and uniformity. Varying mounting heights and elevations require a mix of wide and concentrated distributions to achieve optimal light levels.

ONE WAY DRIVE LANE

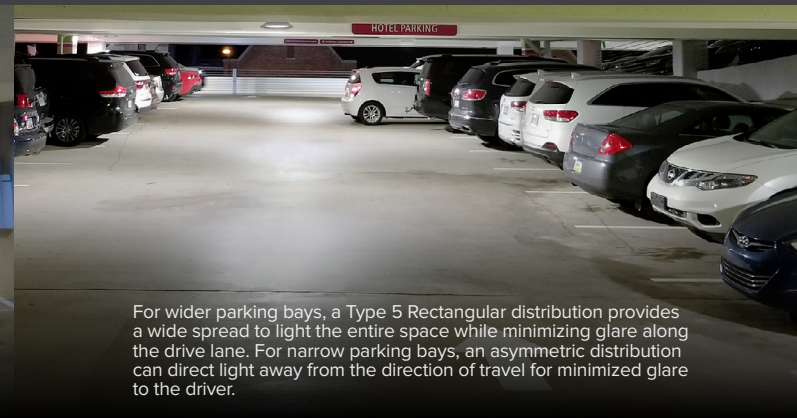

For wider parking bays, a Type 5 Rectangular distribution provides a wide spread to light the entire space while minimizing glare along the drive lane. For narrow parking bays, an asymmetric distribution can direct light away from the direction of travel for minimized glare to the driver.

TWO WAY DRIVE LANE



Ideal application for a square distribution providing maximum uniformity and vertical light throughout the entire parking garage.

UPLIGHT

Optional uplight module provides 800 lumens of indirect illumination for improved visual quality while eliminating cave effect.



Drive Edge-Lit with UD (Uplight option)

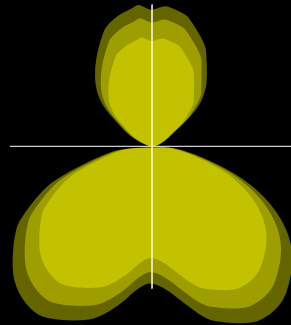

MOUNTING

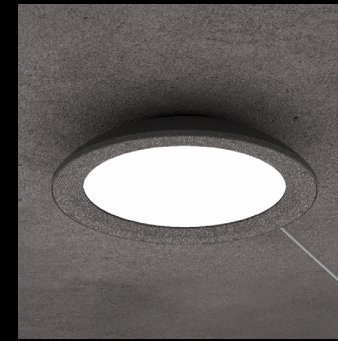

Surface Mount

Mounting plate with “quick mount” hanger for one person simple installation. (conduit not included)



Pendant Mount

Standard 3/4" threaded entry for pendant applications. (Conduit and pendant not included). Pendant available as an accessory.

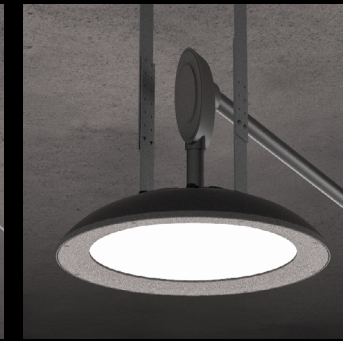

Trunion/Yoke Mount

Multiple position trunion mount adjusts 9" up and down for positioning in 1" increments. (conduit not included)

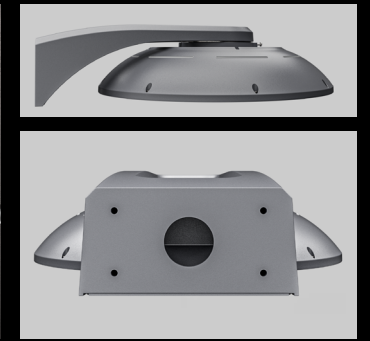

Wall Mount

Wall mount, 4 mounting holes cast into extrusion, 6" x 2.5" spacing with wiring thru-hole.



FEATURES AND ACCESSORIES

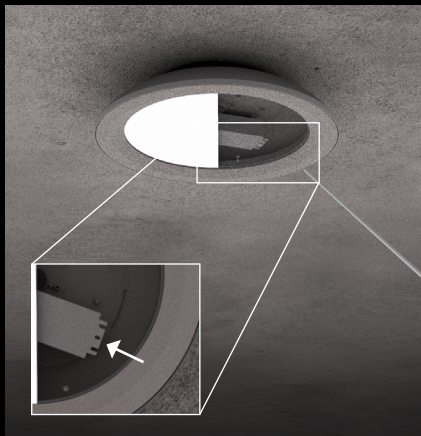

Battery Backup

Integral battery backup option available on SRT2 version.

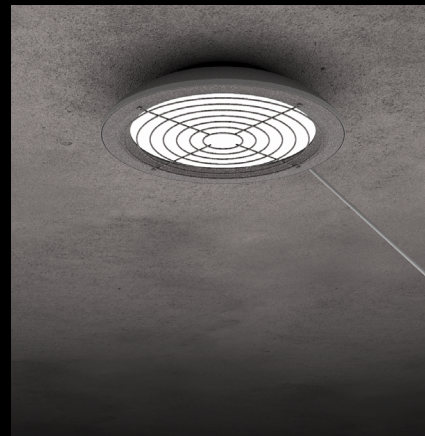

Wire Guard

An optional wire guard can be specified at the factory or as an accessory for field installation. Available for SRT1 and SRT2.



Bird Deterrent

An optional bird deterrent shroud can be specified at the factory or as an accessory for field installation. Available for SRT1 and SRT2.

SIMPLE INSTALLATION



1 Mount plate to junction box.

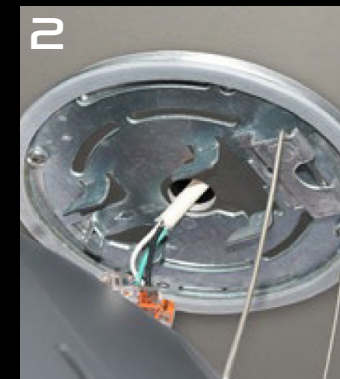

2 Hang fixture on mounting plate with provided integral hook.

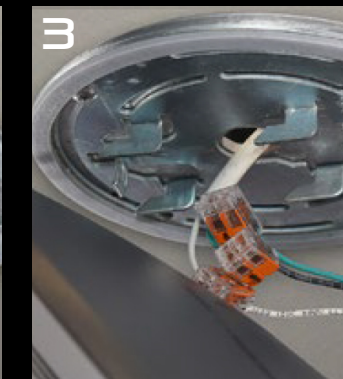

3 Complete wiring connections.

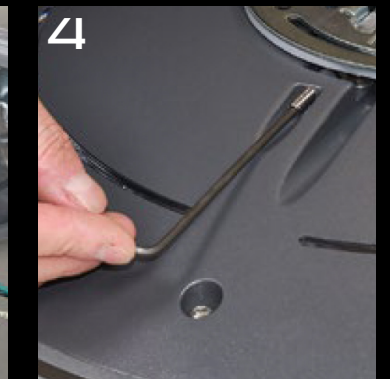

4 Two mounting screws close and secure fixture to the mounting bracket.



CONTROLS

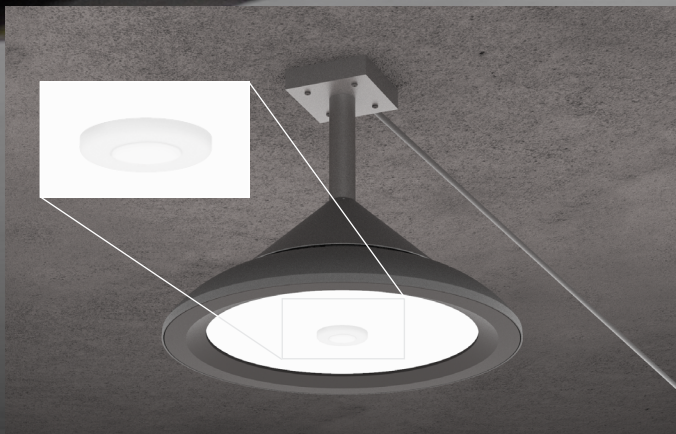

Standalone Controls

NX LIGHTING CONTROLS LIGHTGRID+

Optional NX Lighting Controls™ and LightGRID+ wireless controls are available for SRT2 versions (with or without occupancy sensing).

COMPLETE SOLUTIONS

Current Lighting provides a comprehensive offering of solutions for each unique space within a parking garage application.

STAIRWELLS



Escalate™

TOP DECK

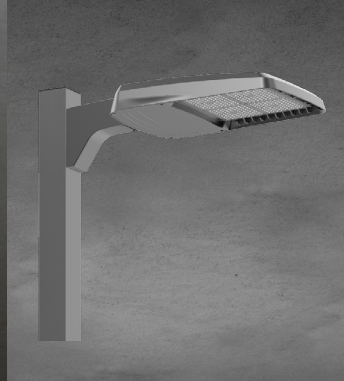

Viper

WALL MOUNT



GeoPak

LIFE SAFETY



Dynamo/SEWL

Columbia
LIGHTING

BEACON
design . performance . technology

DUALITE®

SRT1

ORDERING INFORMATION

Series	Engine	CCT	Distribution	Voltage	Color/Finish	Options
SRT1 Edge-Lit Parking Garage Size 1	20 20W Nominal 2500 lm	3K7 3000K, 70 CRI	5QW Type 5 Square Wide	UNV 120V- 277V	BLT Black Matte Textured	WG Wire Guard
	35 35W Nominal 4000 lm	4K7 4000K, 70 CRI	5C Type 5 Concentrated	120 120V	BLS Black Gloss Smooth	UD ³ Uplight Module
	55 55W Nominal 6000 lm	5K7 5000K, 70 CRI		208 208V	DBT Dark Bronze Matte Textured	F ¹ Single Fuse (120, 277)
				240 240V	DBS Dark Bronze Gloss Smooth	LD3 36" Lead Length ²
				277 277V	GTT Graphite Matte Textured	LD6 72" Lead Length ²
					LGS Light Grey Gloss Smooth	LD9 108" Lead Length ²
					PSS Platinum Silver Smooth	SP10K ³ 10kA Surge Protection with End of Life LED Indicator
					WHT White Matte Textured	LMB Less Mounting Bracket
					WHS White Gloss Smooth	
					VGT Verde Green Textured	
					Color Option	
					CC Custom Color	

Control Options

NX Networked - Wireless	
NXWS12F	NX Networked Wireless Enabled Integral NX SMP2-OMNI-O PIR Occupancy Sensor with Automatic Dimming Photocell and Bluetooth Programming
Sensor Controls	
SCP-8F	Remote control programmable line voltage sensor (8-12' recommended mounting height)
SCP-20F	Remote control programmable line voltage sensor (12-20' recommended mounting height)

- Notes:
- 1 Must specify voltage
 - 2 Standard wire lead length 24"
 - 3 SPI0K LED indicator not available with uplight

DIMENSIONS

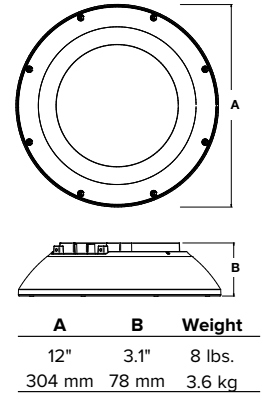

FINISH OPTIONS



Accessories (Order Separately)

- SRT1-WG Wire Guard
- SRT-MB Mounting bracket for pre-installation
- SRT1-BRD Bird deterrent shroud for SRT1 version, not available with uplight
- SCP-REMOTE Remote control for SCP option; order at least on per project to program and control

- WG Wire Guard
- UD³ Uplight Module
- F¹ Single Fuse (120, 277)
- LD3² 36" Lead Length
- LD6² 72" Lead Length
- LD9² 108" Lead Length
- SP10K³ 10kA Surge Protection with End of Life LED Indicator
- LMB Less Mounting Bracket

SRT2

ORDERING INFORMATION

Series	Engine	CCT	Distribution	Voltage	Color/Finish	Options
SRT2 Edge-Lit Parking Garage Size 2	25 25W Nominal 3800 lm	3K7 3000K, 70 CRI	5QW Type Square Wide ⁴	UNV 120V- 277V	BLT Black Matte Textured	WG Wire Guard
	45 45W Nominal 5500 lm	3K8 3000K, 80 CRI	5RW Type 5 Rect. Wide ⁴	120 120V	BLS Black Gloss Smooth	UD Uplight Module
	60 60W Nominal 7000 lm	35K8 3500K, 80 CRI	5C Type 5 Concentrated	208 208V	DBT Dark Bronze Matte Textured	F Single Fuse (120, 240, 480V) ⁷
	80 80W Nominal 9200 lm	4K7 4000K, 70 CRI	5W Type 5 Wide ³	240 240V	DBS Dark Bronze Gloss Smooth	F Double Fuse (208, 240, 480V) ⁷
	90 90W Nominal 11000 lm	4K8 4000K, 80 CRI	ASY Asymmetric (Type 4) ⁴	277 277V	GTT Graphite Matte Textured	E EM Battery Pack (0°C) ^{2,6}
	105 105W Nominal 13000 lm	5K7 5000K, 70 CRI		347 347V	LGS Light Grey Gloss Smooth	EH EM Battery w/Heater (-30°C) ^{2,6}
	130 130W Nominal 15250 lm			480 480V	PSS Platinum Silver Smooth	DTS Dimming Transfer Switch ^{1,2}
					WHT White Matte Textured	LD3 36" Lead Length
					WHS White Gloss Smooth	LD6 72" Lead Length
					VGT Verde Green Textured	LD9 108" Lead Length
				Color Option	SP20K 20kA Surge Protection with End of Life Indicator	
				CC Custom Color	LMB Less Mounting Bracket	
					SP 10kA Surge Protector	
					CD Continuous Dimming	

Control Options

NX Networked - Wireless ⁹	
NXW	NX Networked Wireless Radio Module NXRM2 and Bluetooth Programming, without Sensor
NXWS12F	NX Networked Wireless Enabled Integral NX SMP2-OMNI PIR Occupancy Sensor with Automatic Dimming Photocell and Bluetooth Programming
LightGRID+ - Wireless	
WIR	LightGRID+ In-Fixture Module
WIRSC8F	LightGRID+ with remote control programmable line voltage sensor (8-12' recommended MH) ⁸
WIRSC40F	LightGRID+ with remote control programmable line voltage sensor (12-20' recommended MH) ⁸
Sensor Controls ⁹	
BTS012F	Bluetooth Programmable, BTSMP-OMNI-O PIR Occupancy Sensor with Automatic Dimming Photocell and 360° Lens
BTS14F	Bluetooth Programmable, BTSMP-LMO PIR Occupancy Sensor with Automatic Dimming Photocell and 360° Lens
BTS40F	Bluetooth Programmable, BTSMP-HMO PIR Occupancy Sensor with Automatic Dimming Photocell and 360° Lens

Accessories (Order Separately)¹⁰

- SRT2-WG Wire Guard for SRT2 version
- SRT2-MB Mounting bracket for pre-installation
- SRT2-BS-XXX Bird deterrent shroud for SRT2 version
- SRT2-TM-XXX Trunion/Yoke accessory for SRT2 version
- SRT2-WM-XXX Wall Mount
- CLEDSJK Whiteway stem and junction box

DIMENSIONS

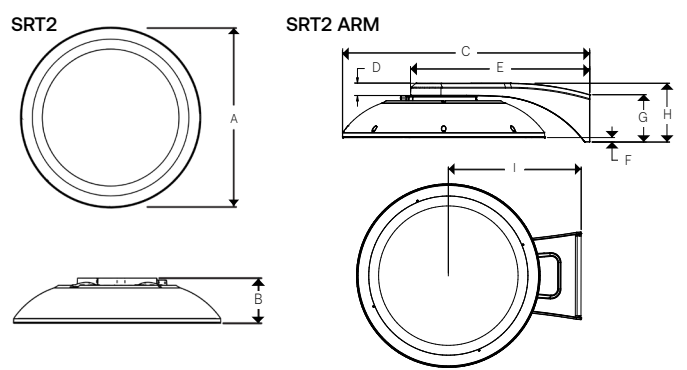

A	18.5" (469mm)	F	4" (102mm)
B	4.0" (102mm)	G	4.3" (109mm)
C	22.7" (577mm)	H	5.4" (137mm)
D	11" (280mm)	I	13.4" (340mm)
E	16.4" (417mm)	WEIGHT	15lbs (6.8kg)



- Notes:
- 1 For applications that must comply with UL924. Can not be combined with E or EH options
 - 2 Available for 120 to 277 volts only, not 347 or 480
 - 3 90W, 105W, and 130W configurations only
 - 4 25W, 45W, 60W, and 80W configurations only.
 - 5 Available for 60W and higher
 - 6 E and EH: 25W and 45W only
 - 7 Not available for UNV, must select Voltage
 - 8 Available in 120V or 277V only
 - 9 Not available for 480V
 - 10 "XXX" should be replaced with fixture color, for example WM-DBT, Wall Mount Dark Bronze Textured

Current

Current - HLI Brands

701 Millennium Blvd.
Greenville, SC 29607

currentlighting.com/Beacon

© 2024 Current Lighting Solutions, LLC. All rights reserved. Information and specifications subject to change without notice. All values are design or typical values when measured under laboratory conditions.

(Rev 12/19/24)

BEA_SRT2_EdgeLit_Gen2_Brochure_R01
