



INSTRUCTIONS PERTAINING TO A RISK OF FIRE, OR INJURY TO PERSONS
IMPORTANT SAFETY INSTRUCTIONS!

⚠ WARNING: Fixtures must be grounded in accordance with local codes or the National Electrical Code. Portable spear or tree mounts using a cord and plug, must be plugged into a receptacle protected by a Ground Fault Circuit Interrupter (GFCI) in accordance with the National Electrical Code. Failure to take these steps may result in serious personal injury.

MAINTENANCE: To maintain light efficiency and prevent fixture overheating, lenses must be kept clean and free of dirt, dust, leaves, trash and mineral deposits from water. For optimum performance a regularly scheduled maintenance program should be followed.

NOTE: All electrical work must be done by a qualified electrician. **KEEP THIS SHEET FOR FUTURE REFERENCE.**

KIM H.I.D. landscape luminaires combine the latest lamp technology with proven fixture design and engineering. Direct burial products feature a heavy wall compression molded composite ballast box with cast bronze cover, and separate ballast and splice compartments are divided by anti-syphon barriers.

The following examples exhibit explanations and details of typical applications and techniques that KIM Lighting recommends for practical successful lighting installations. Direct burial boxes must be conduit fed for input and output voltages.

Direct Mount Fixtures:

Fixtures can be set directly into soil, gravel, or concrete. It is recommended that the ballast box be slightly elevated to encourage water drainage away from fixture.

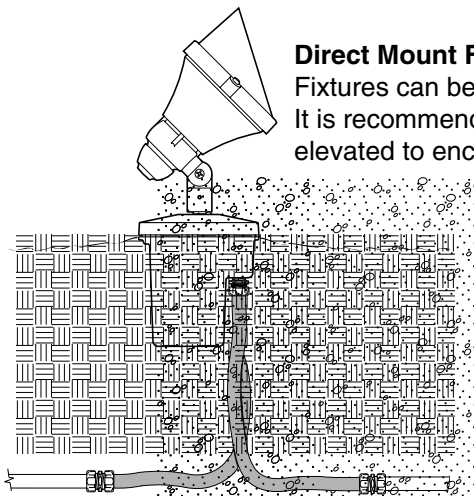

Remote Mount Fixtures:

Remote mount fixtures are designed for use in areas where you can place the ballast box out of view and install the fixture in an area where maintenance can be performed easily. Remote mount fixtures are the perfect choice for down lighting applications as fixtures can be placed in trees while keeping the power source below grade.

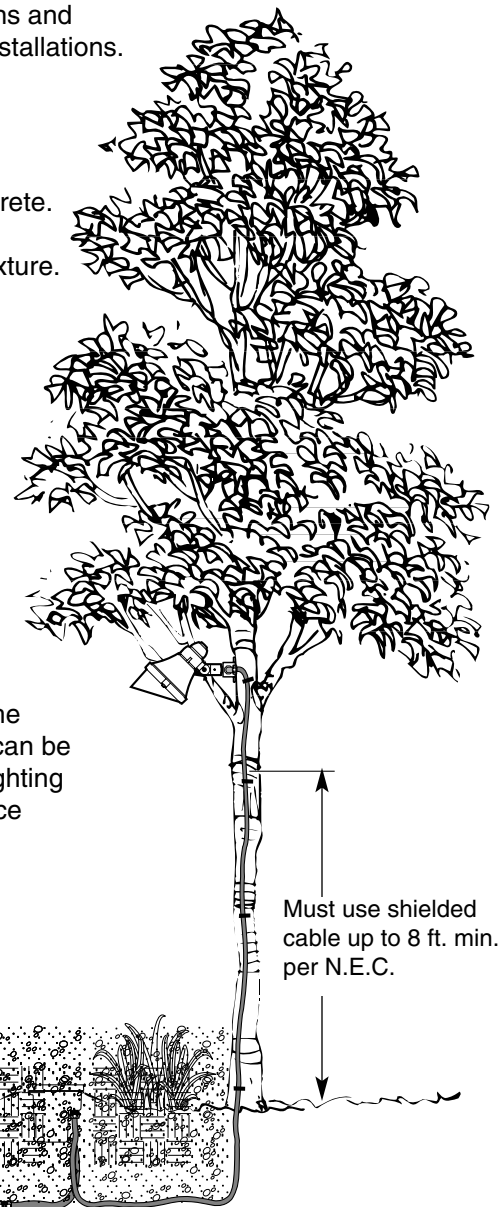
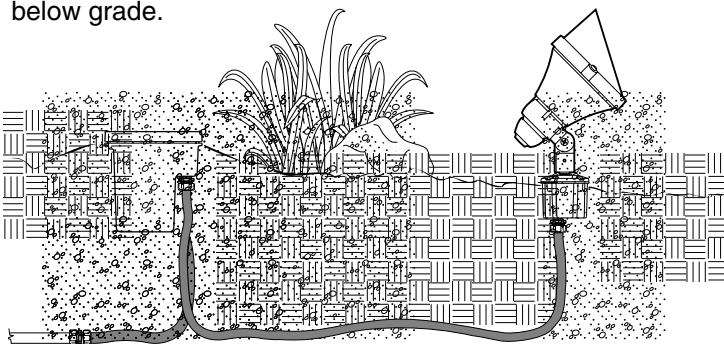



Your KIM fixture ballast box includes a pre-wired ballast. The box has two (2) covers. Only the outside cover should be removed during installation. The ballast box has two (2) 3/4" NPT taps and one (1) 1/2" NPT tap in the bottom.

Important! If your fixture has been ordered as either 120V, 208V, 240V or 277V, the ballast box is equipped with a multi-tap ballast. Any one of these four voltages can be selected by removing the ballast cover and connecting the input lead to the required voltage on the terminal block.

CAUTION: Field wires must be rated 90° C. minimum.

Tools Required: 3/16" Allen Wrench Flat Blade Screwdriver Silicone Grease Thread Sealant

Installation Instructions: ⚠ Make certain electrical supply is **OFF** before starting installation.

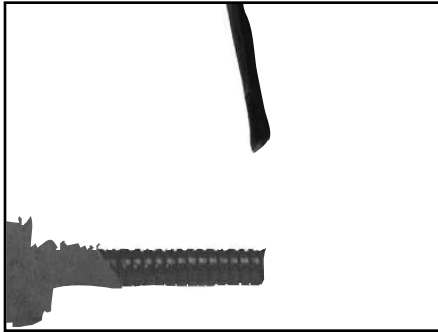

1. Coat conduit fitting threads with a good sealant and connect conduit.

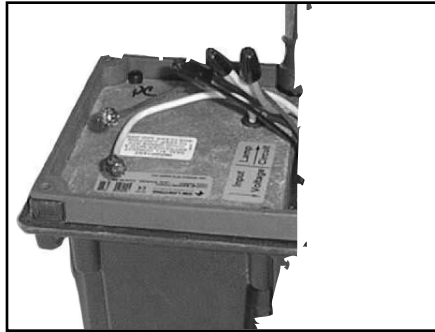

2. Seal conduit entries with a good grade RTV sealant (such as GE 108).

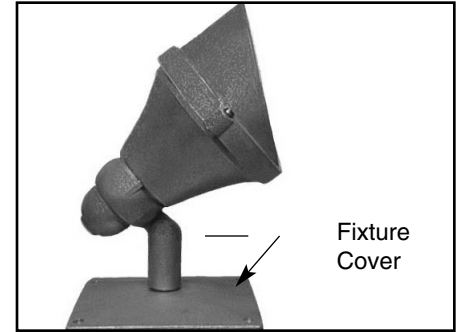

3. Coat fixture mounting threads with sealant. Install fixture onto cover per fixture instructions (direct mount), tighten locking screw.



4. Make certain all grounding leads are connected to the incoming ground circuit. Make wiring connections as per wiring label in ballast compartment. Clean gasket and gasket surface. Coat cover screw threads with silicone grease and install cover.

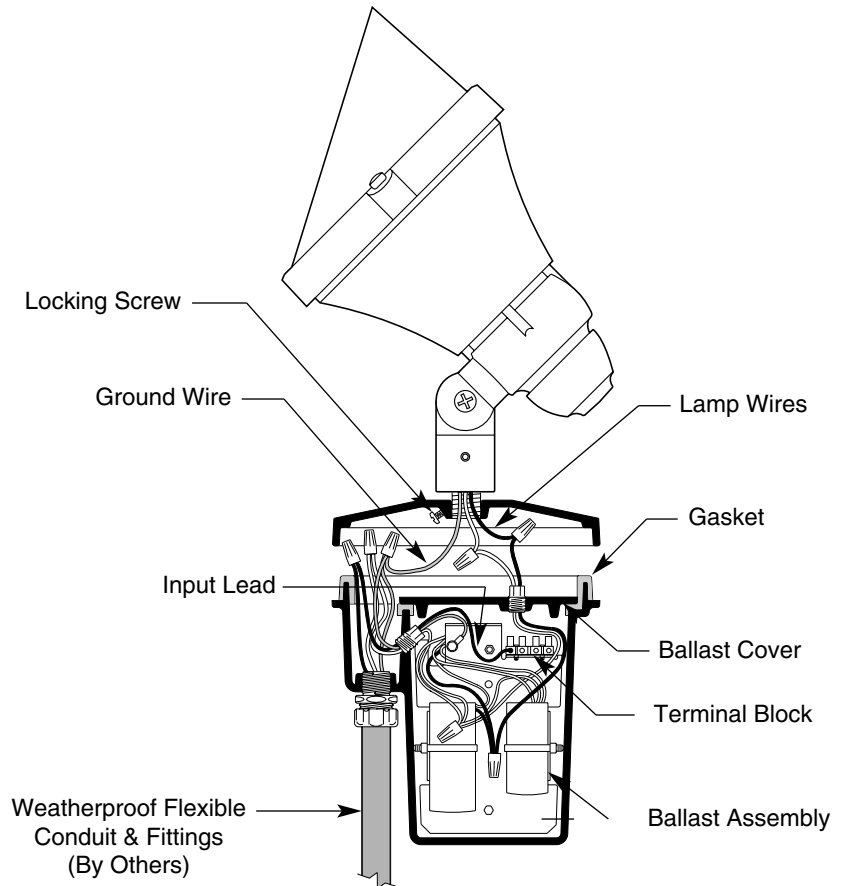

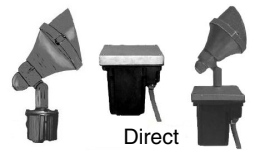
**KIM LIGHTING LIMITED WARRANTY**

When installed in accordance with Kim Installation Instructions and accepted trade practices, the following shall apply:

⚠ General Product Limited Warranty Coverage: All material and component parts used in the manufacture of Kim Products, are warranted to be free from defects of material and/or workmanship for a period of 1 year from date of sale, with the following exceptions:

⚠ Auxiliary Equipment: All auxiliary equipment (such as lamps, ballasts, and transformers) provided by and/or included in Kim Products shall carry the component manufacturer's warranty.

⚠ Copper and Bronze Landscape Components: Copper and Bronze Landscape fixture components shall be warranted against defects of material and/or workmanship, and failure due to corrosion, for a period of 25 years from date of sale.

⚠ Composite In-Grade Components: Composite In-Grade fixture components installed below grade, shall be warranted against defects of material and/or workmanship, and failure due to corrosion, for a period of 7 years from date of sale.

⚠ Aluminum Landscape Components: Aluminum Landscape fixture components not in direct contact with soil, shall be warranted against defects of material and/or workmanship for a period of 3 years from date of sale. Aluminum fixture components in direct contact with soil shall be warranted from defects of material and failure from corrosion for a period of 1 year from date of sale.

⚠ Limit of Liability and General Conditions: Only products which are installed, used and maintained in accordance with applicable Kim instructions, specifications, and accepted trade practices, are covered by the Kim Warranty. During the warranty period, with proof of purchase, Kim will repair or replace with the same or similar product, at Kim's option, without charge. Labor costs are the owner's responsibility and are excluded from this warranty. This warranty is void if the product is modified, tampered with, misapplied, poorly installed, improperly maintained, or subjected to abnormal conditions.

Repair or replacement as provided under this warranty is the exclusive remedy of the purchaser. This warranty is in lieu of all other warranties, expressed or implied, including any implied warranty of fitness for a particular application. Kim Lighting shall not be liable to the purchaser for indirect or consequential damages.

How may we serve you better?
Please let us know. Visit our website at:
currentlighting.com/kimlighting
Your input matters to us.