

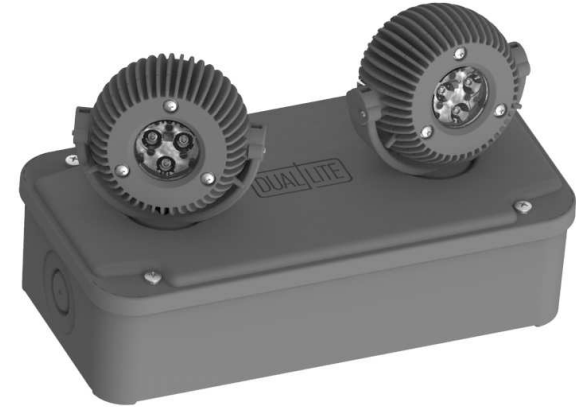

**LED Industrial Emergency Light Fixture
Intended For Use With ELSS System
Installation, Operation and Service Instructions**



93139174

Maintenance

This emergency lighting unit should be tested and maintained in accordance with National Electrical Code and NFPA 101 Life Safety Code requirements. It is recommended that emergency light fixtures be tested for 60 seconds once a month and for 90 minutes once a year.

Taking A Unit Out Of Service

If a unit is to be deliberately taken out of service for an extended period, the battery lead connector should be disconnected from the charger circuit board and insulated so that the battery will go into storage in a fully charged condition.

Replacing The Battery

The Emergency Light Fixture is a remote unit. The system battery is located in the ELSS Main Unit.

Replacing LED Lamps

The LED lamps inside the unit are not replaceable or field serviceable. Please see dual-lite.com for further assistance.

Troubleshooting

Emergency circuit does not work

- Batteries are shipped uncharged and disconnected. Connect battery leads and charge 24 hours before testing.
- Make sure the charger board and test button and indicator lights are properly seated and aligned.
- Check wiring connections



RECYCLING INFORMATION

All steel, aluminum and thermoplastic parts are recyclable.
NOTICE: Emergency units contain rechargeable batteries which must be recycled or disposed of properly.

93138624_A

IMPORTANT SAFEGUARDS

When using electrical equipment, basic safety precautions should always be followed including the following.

READ AND FOLLOW ALL SAFETY INSTRUCTIONS

1. Do not let power supply cords touch hot surfaces.
2. Do not mount near gas or electric heaters.
3. Equipment should be mounted in locations and at heights where it will not readily be subject to tampering by unauthorized personnel.
4. The use of accessory equipment not authorized by the manufacturer may cause an unsafe condition.
5. Do not use this equipment for other than its intended purpose.
6. Servicing of this equipment should be performed by qualified service personnel.
7. Test cycling: the Life Safety Code (NFPA 101) requires testing of emergency lighting units once a month for a minimum of 60 seconds, and once a year for a minimum of 90 minutes.

INSTALLER:

- SEE UNIT LABEL FOR ADDITIONAL MODEL SPECIFICATIONS
- SAVE THESE INSTRUCTIONS FOR USE BY OWNER/OCCUPANT

WARNING – This product contains chemicals known to the State of California to cause cancer, birth defects and/or other reproductive harm. Thoroughly wash hands after installing, handling, cleaning, or otherwise touching this product.



Current Lighting Solutions, LLC

701 Millennium Blvd.
Greenville, SC 29607

currentlighting.com/dual-lite

© 2022 HLI Solutions, Inc. All rights reserved. Information and specifications subject to change without notice. All values are design or typical values when measured under laboratory conditions.

Rev 06/07/22

DL_ELWR_INST_R01



NOTE:

The ELWR fixture can be wall mounted at a height of 7ft to 10ft. Each LED lamp head can be adjusted on 2 axis for desired beam angle.

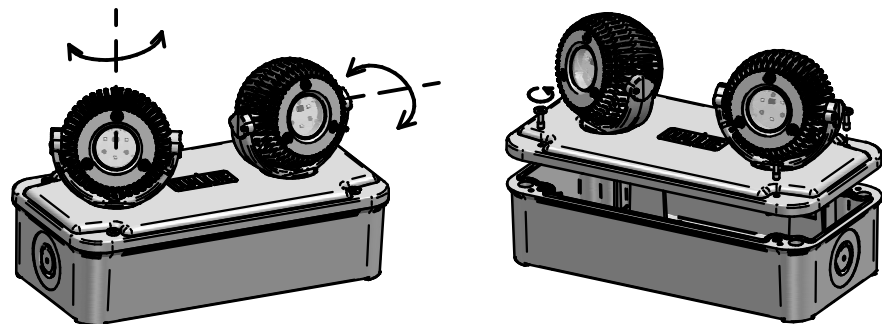

Step 1

Remove cover by removing the (4) screws that secure it to the housing.

Step 2

Remove 7/8" DIA. knock-out (K.O.) from backplate if mounting to electrical box or remove 1/2"-1/4 NPT pipe plug if using conduit.

CONDUIT MOUNTING:

If unit is not secured to mounting surface using unit backplate K.O. pattern and supplied gasket, use sealant to create waterproof seal between the mounting surface and the unit backplate.

IMPORTANT!

To weatherproof your outdoor installation, be sure to seal all fixture openings - mounting, conduit, etc.

Step 3

Remove appropriate backplate K.O.'s for electrical box screws.

Step 4

Peel backing from J-Box Gasket and adhere to backplate around center K.O.

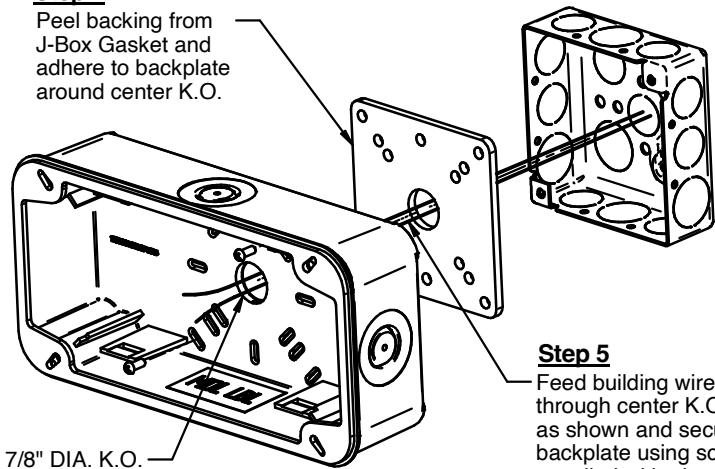

Step 5

Feed building wires through center K.O. as shown and secure backplate using screws supplied with electrical box.

GREEN LED Indicator is illuminated when AC power is present.
 YELLOW LED Indicator is illuminated when in Emergency Mode.

NOTE: All models are supplied with an AC Lockout circuit, which prevents the emergency lights from illuminating when the battery is connected and no AC power is present.

NOTE: All models are supplied with a Low Voltage Disconnect circuit, which prevents damage to the battery from deep discharge during prolonged emergency operation.

NOTE: Batteries are often shipped in a discharged state – this is normal. The battery will require charging. Allow 24 hours of charging before testing the unit.

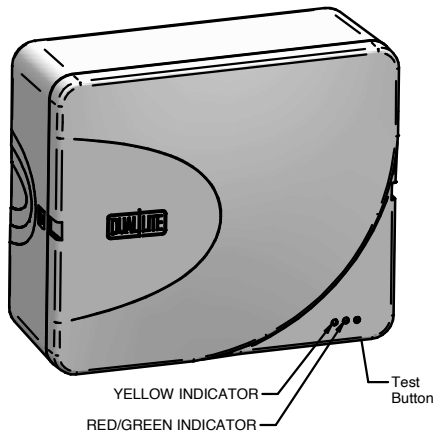

Models with SPECTRON® Self-Testing/Self-Diagnostic Circuitry

Models equipped with the Spectron® self-testing/self-diagnostic electronics system provide:

Visual indication of AC power status Visual indication of self-diagnostic test status and results

– Visual indication of any unit malfunctions include –

Battery Disconnected Battery Fault Charger Fault Transfer Fault Load Fault

Spectron equipped units also include:

Brownout protection: unit will automatically transfer to emergency operation upon detection of low AC power (approximately 80% of nominal line).

Time Delay Retransfer: upon return of normal AC power, unit will remain in emergency mode for an additional 15 minutes to allow AC power to stabilize.

LED Status Indicator

A bicolor LED (green/red) is provided on the control panel of all models equipped with the Spectron® option.

Green Operating Status LED:

The green Operating Status LED serves as both an AC power and self-test indicator. During normal operation, the green Operating Status LED will be illuminated, indicating the presence of AC power. During all automatic or manual self-test cycles, the green Operating Status LED will blink twice every second.

Red Service Alert LED:

Under normal operating conditions, the red Service Alert LED indicator will remain off. If the Spectron® controller detects a malfunction, the red Service Alert LED will blink in the pattern listed in the following table:

Red Status LED Code	Description
One blink ON/pause	Battery disconnected
Two blinks ON/pause	Battery fault
Three blinks ON/pause	Charger fault
Four blinks ON/pause	Transfer fault
Five blinks ON/pause	Load fault
Red/Green alternating	Load Learn in Process

Automatic Tests

The unit will automatically initiate a self-test/self-diagnostic cycle based on the following table:

Testing Period	Duration of Test
Once a month	1 minute
Once every 6 months	Alternating: 30 minutes or 90 minutes

Manual Tests

Using the unit test switch, users can initiate different duration test cycles based on the following table:

Initiating Action	Test Cycle
Press test switch once	1 minute
Press test switch twice	90 minutes

Pressing the test switch any time after a 90 min. test cycle has begun cancels the remainder of the 90 min. test and returns the unit to normal operation.

Step 6

Install DC wiring (12-18AWG depending on wire length) from either J-box or conduit connection for wall mount. Loosen wire connector screw on LED driver board and insert wires for (+) and (-) connections. Tighten screw to secure wire connection. It is important to note that all field terminals are pre-tightened. Loosen prior to wire insertion. Do not over tighten terminal blocks.

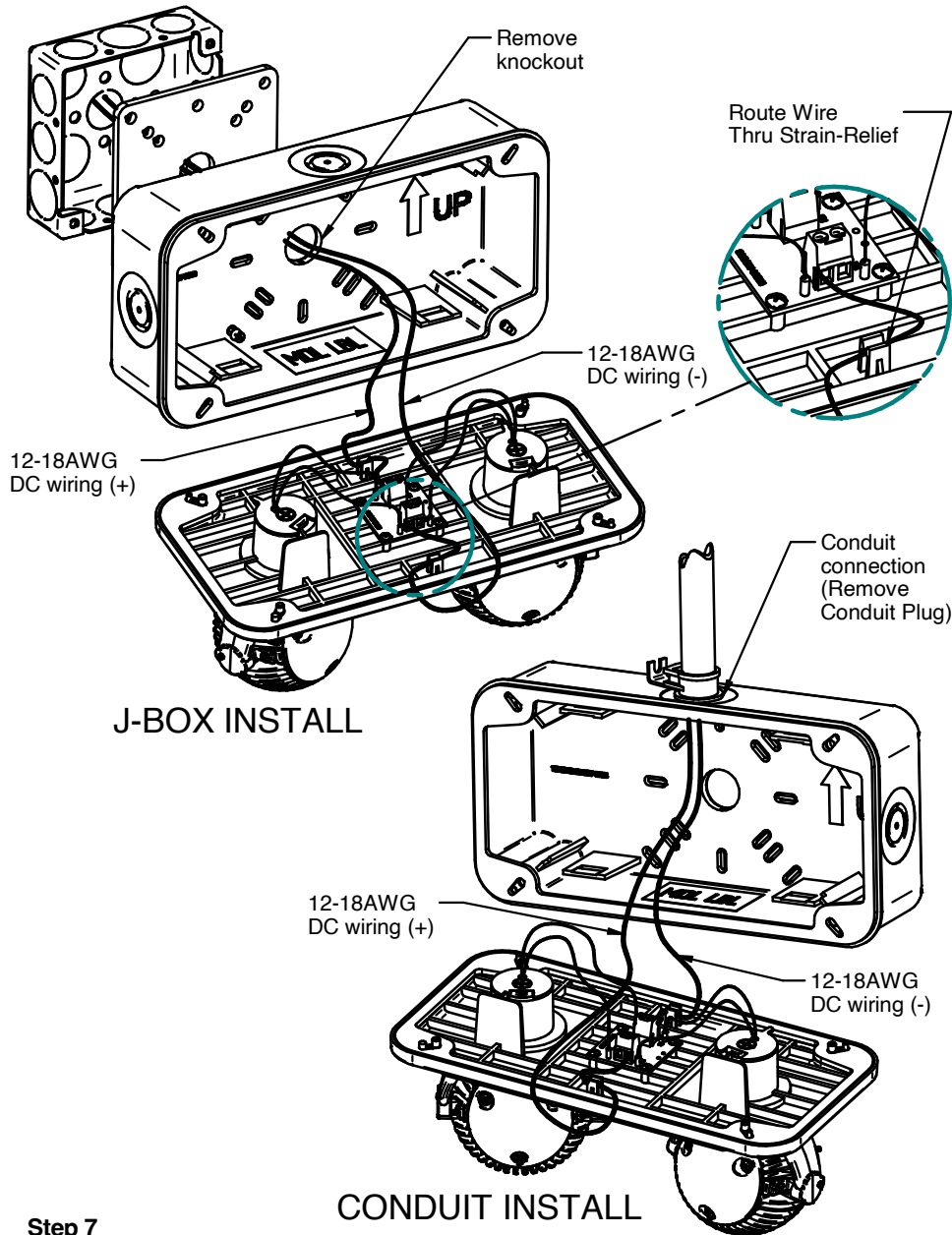

Step 7

Reinstall cover with (4) screws removed in Step 1.

NOTE: Ensure all wires are within enclosure to avoid pinching with cover.

Wiring Diagram

NOTE: Wiring used shall be 12-18AWG for all ELSS remote fixtures, 14-18AWG for ELSS Exit Signs. Do not exceed 5% voltage drop on wire run length between ELSS Main System and connected fixtures. See ELSS instruction sheet for wiring details.

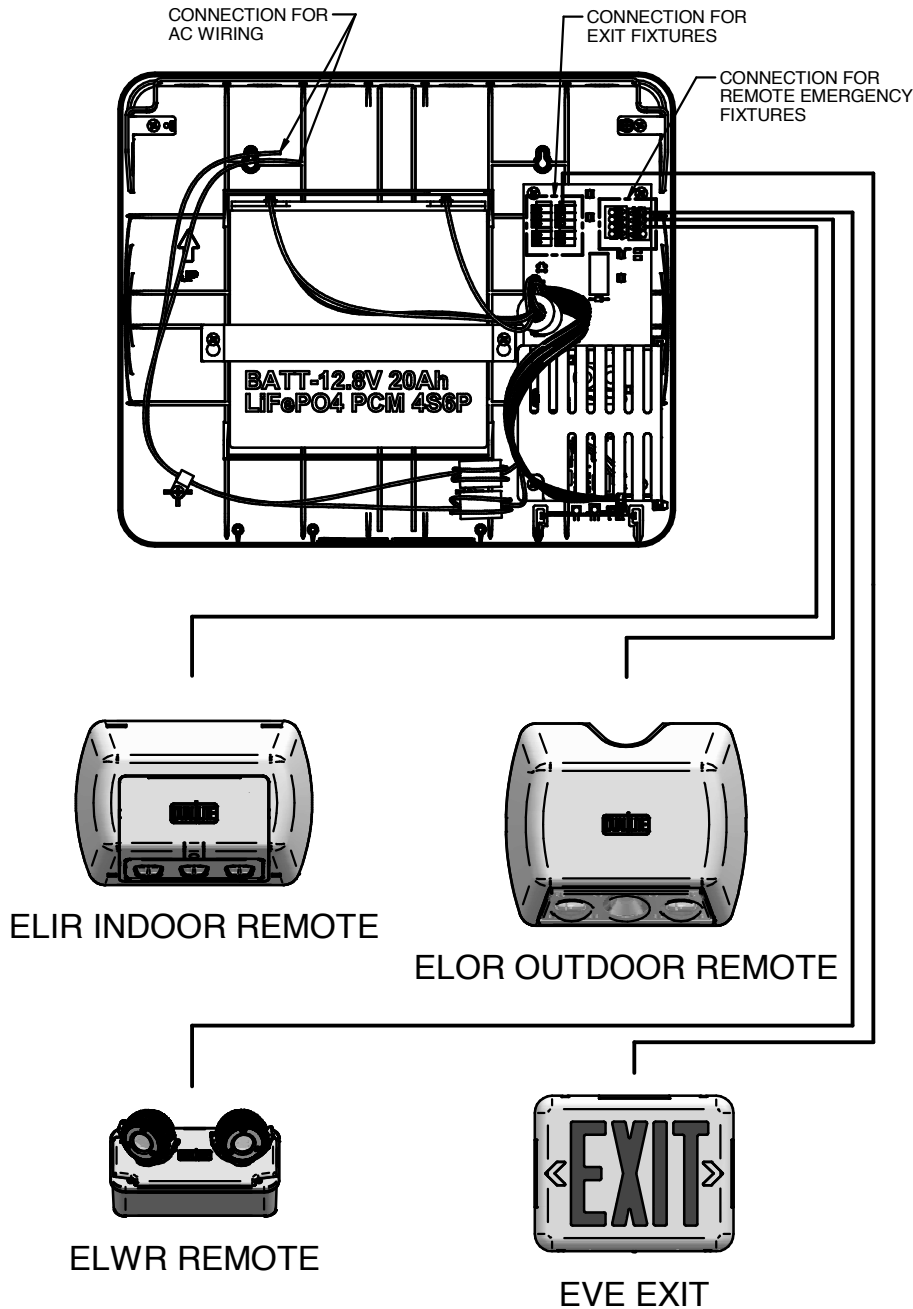

Configuring the ELSS system requires calculation of total wattage capacity for both the ELSS remote circuit and ELSS exit sign circuit.

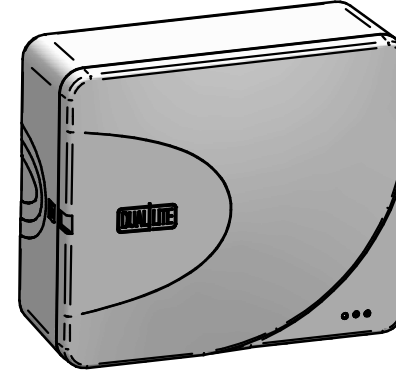

ELSS capacity: Remotes

- ELSS 100W = 100W total remote load
- ELSS 75W = 75W total remote load
- ELSS 50W = 50W total remote load

ELSS capacity: Exit Signs

- ELSS 100W = 15W total exit sign load
- ELSS 75W = 10W total exit sign load
- ELSS 50W = 7.5W total exit sign load

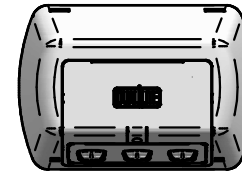

ELIR INDOOR REMOTE

ELIR wattage for calculation:

- ELIR3 = 8W
- ELIR3B = 8W
- ELIR2 = 3W
- ELIR2B = 3W
- ELIR2HP = 6W
- ELIR2HPB = 6W

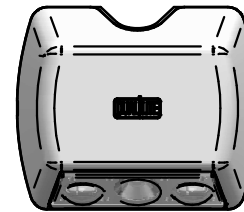

ELOR OUTDOOR REMOTE

ELOR wattage for calculation:

- ELORW = 8W
- ELORB = 8W
- ELORDB = 8W



ELWR REMOTE

ELWR wattage for calculation:

- ELWRD = 10W
- ELWRDHP = 16W



EVE EXIT

EVE Exit wattage for calculation:

- EVEURW-DC ELSS = 1W
- EVEUGW-DC ELSS = 1W