

Lumination® LED Luminaire

LUS Series

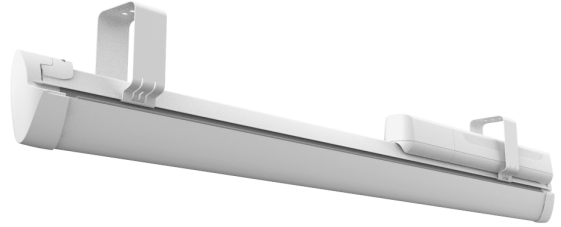

BEFORE YOU BEGIN

Read these instructions completely and carefully.

⚠ WARNING / AVERTISSEMENT

RISK OF ELECTRIC SHOCK

- Turn power off before inspection, installation or removal.
- Properly ground electrical enclosure.

RISK OF FIRE

- Follow all NEC and local codes.
- Use only UL approved wire for input/output connections.
- Minimum size 18AWG or 14AWG for continuous runs.
- When using multi-branch wire circuits with a shared neutral, do not operate any circuit with the neutral open. Also ensure all neutral connections are secure before energizing the circuit. An open neutral can cause an over-voltage condition at the Luminaire power supply.

RISQUES DE DÉCHARGES ÉLECTRIQUES

- Coupez l'alimentation avant d'inspecter, installer ou déplacer le luminaire.
- Assurez-vous de correctement mettre à la terre le boîtier d'alimentation électrique.

RISQUES D'INCENDIE

- Respectez tous les codes NEC et codes locaux.
- N'utilisez que des fils approuvés par UL pour les entrées/sorties de connexion. Taille minimum 18 AWG ou 14 AWG pour les rangées continues.
- Lorsque vous utilisez des circuits câblés à branches multiples avec un neutre commun, ne mettez aucun circuit en service avec le neutre ouvert. Assurez-vous également que tous les raccords neutres soit sécurisés avant de mettre le circuit sous tension. Un neutre ouvert peut causer une condition de surtension à l'alimentation du luminaire.

Prepare Electrical Wiring



Electrical Requirements

- The LED luminaire must be connected to the main supply according to its ratings on the product label.



Grounding Instructions

- The grounding and bonding of the overall system shall be done in accordance with National Electric Code (NEC) Article 600 and local codes.

IMPORTANT

Maximum Length of Electrical Run

Voltage	8ft Lumen Code			
	[84]	[A02] [A2]	[A3] [A7]	[B1] [B4]
120V	192'	160'	80'	60'
277V or 347V	400'	320'	188'	132'

- Maximum driver current through connected fixtures shall not exceed 15A for lumen codes [42], [52], [62], [84], or [A0].
- Maximum driver current through connected fixtures shall not exceed 12A for lumen codes [65], [85], [A3], [A7], [A1], [A2], [B1] or [B4].

IMPORTANT NOTE: LUS series luminaires come in two versions: continuous units and independent units. A continuous electrical run will consist of a number of continuous units up to a maximum current specified above. When installing luminaires use clean gloves in order to avoid fouling the reflective surface. To insure a clean fixture, install the fixture with the plastic bag around the fixture, and then remove plastic bag upon completion of any and all construction related activity.

Special Instructions for [TQ] and [TS] SKUs — Node Identification Label

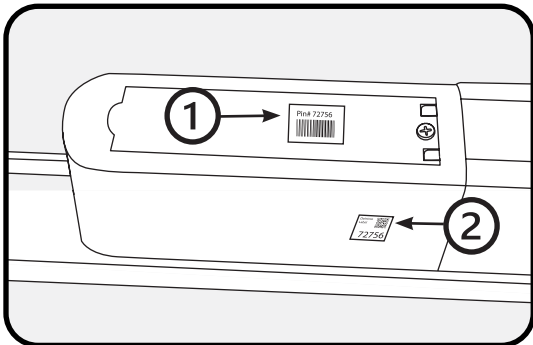

- 1 Node identification label for the customer’s floor plan.
- 2 Node identification label for the luminaire.
- 3 Daintree Node identification label installed on luminaire back reflector.

Installation of an Independent Luminaire

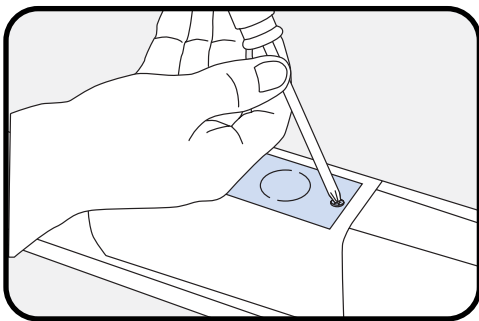

- 1 Prepare luminaire for installation by loosening the knockout plate screw and removing the knockout plate. Remove knockouts as required and pass wires through using UL listed strain reliefs.

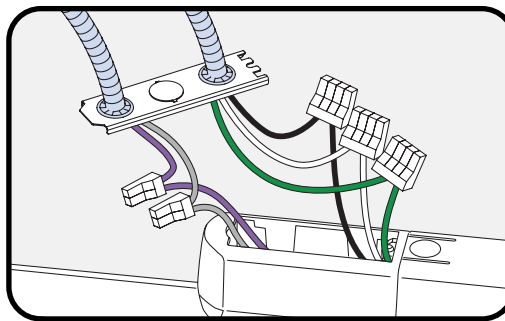

- 2 Connect the green (ground), black (line) and white (neutral) of the AC line to corresponding colored wires of the PSU using provided push-in wire connectors or separate UL listed wire nuts. Replace knockout plate and tighten the screw.

OPTIONAL: Connect dimming pink and violet wires to corresponding colored fixture wire using provided push-in wire connectors or UL listed wire nuts.

Wiring Diagrams

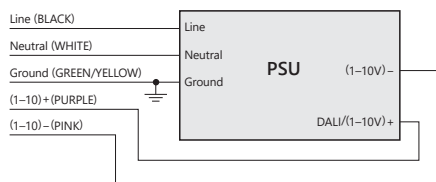

1-10V Standard Wiring Diagram

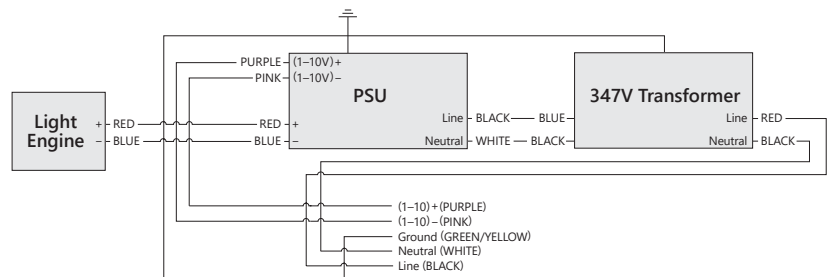

1-10V 347V Wiring Diagram

Installation of Brackets for Independent Luminaire

Maximum distance between suspension points shall not exceed the length of the luminaire.

Continuous run option: Row must begin with a first fixture that is suspended at both ends.

Use provided endcaps from starter kits to begin and terminate the row.

1 Suspension bracket — Type 2.

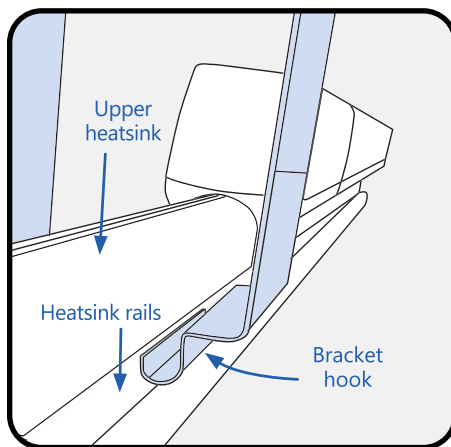

- 2 Place the bracket on the rails of the heatsink so that its hook is around the upper part of the heat sink.

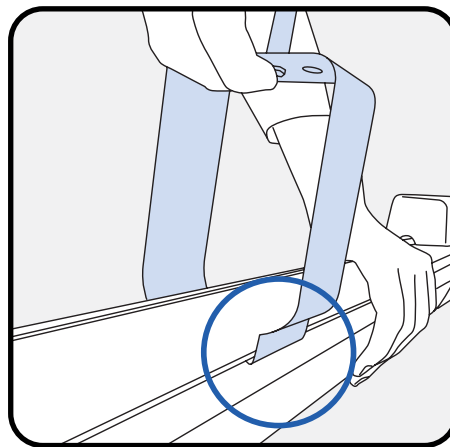

- 3 Pull the bracket upward so that the hooks of the bracket are directly aligned with the upper heatsink.

NOTE: Above is the correct final bracket installation on upper heatsink.

NOTE: Slide the bracket along the heatsink rails until desired location is achieved.

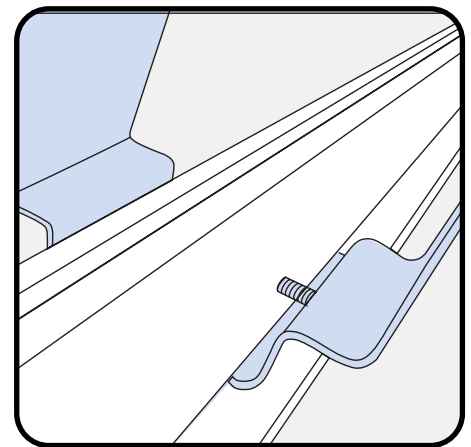

- 4 Attach the suspension mechanism to each bracket by following the suspension kit instructions. Next, suspend the continuous fixture from the ceiling.

- 5 Once each bracket is in the appropriate location with respect to the fixture, secure the bracket by tightening the pre-install screw on either side of the bracket. The screw needs to be touching the upper heatsink.

Installation of a Continuous Luminaire with Optional Branch Circuit

NOTE: For continuous luminaires, a starter kit must be purchased separately.

- 1 Follow the steps 1–6 from the previous section, Installation of Independent Luminaires.
- 2 **NOTE:** For “BC” option code with additional branch circuit the PSU input wires (black and white) will not be connected. These wires should be connected to the appropriate circuit for each luminaire depending on the desired functionality.

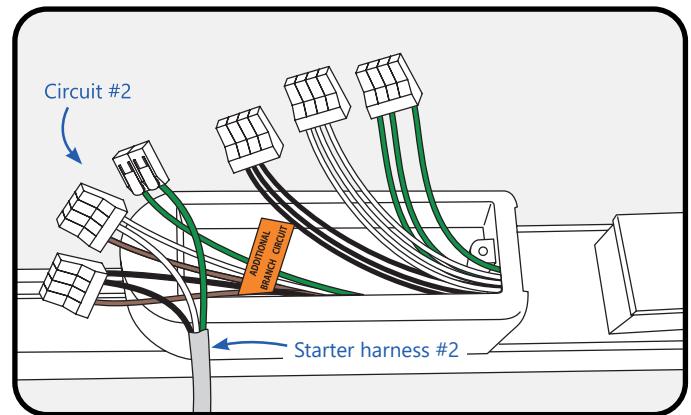
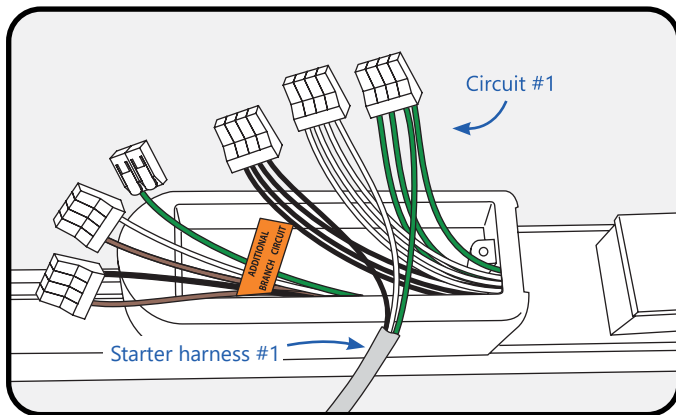

- 2a **Circuit #1 connection:** Connect the green (ground), black (line) and white (neutral) wires of AC line to the corresponding colored wires of the starter harness using push-in connectors.

- 2b **Circuit #2 connection:** Connect the green (ground), brown (line), and brown/white (neutral) wires of the additional branch circuit to the green, white, and black colored wires of the starter harness using push-in connectors.

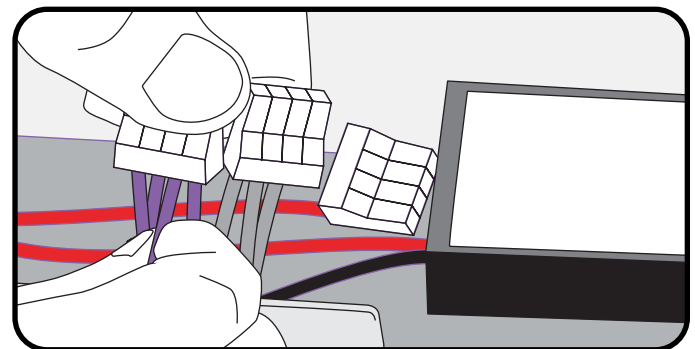
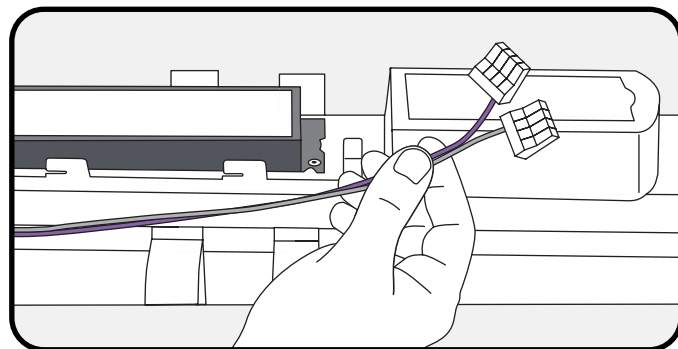

- 3 **Optional dimmer:** Connect dimming control wires (pink & violet for 0-10V) to similarly colored fixture wires using the provided ideal connectors. Connect dimming control harness provided in the Starter Kit to connect to the dimming leads.

NOTE: Optional branch circuit can be used for A/B switching by moving black and white PSU wires of “B” fixtures onto brown and brown/white wires.

On an additional circuit that requires its own neutral. Note that the brown/white is a neutral for the brown line. For “EL” option SKU, see **Emergency Light Supplement** for wiring diagram.

For additional guidance please refer to **NEC 2014 Section 410.64 Part C - Wiring Supplying Luminaires connected together.**

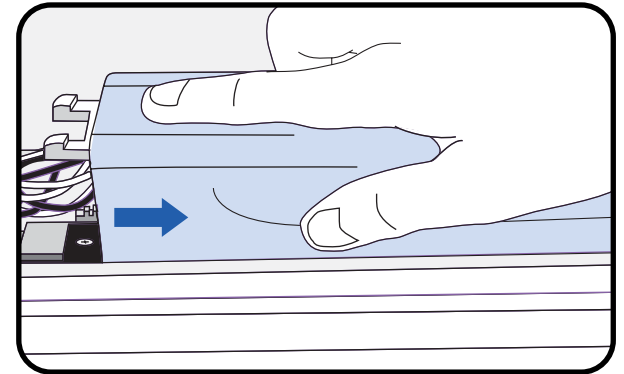
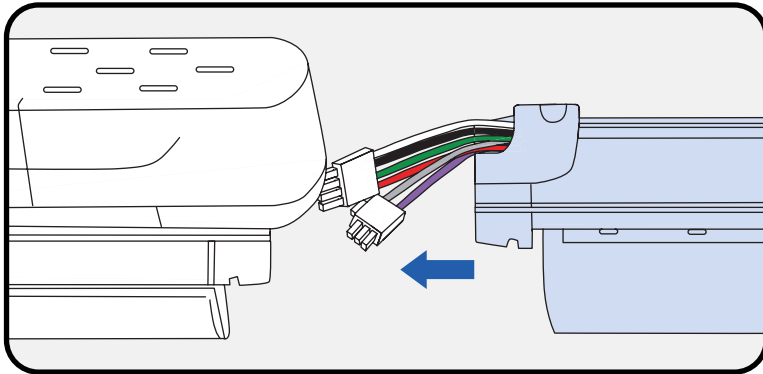

4 Once the first fixture is wired correctly, including the dimming leads, you can attach the second fixture.

5 Remove the PSU cover of the first fixture, by pressing down on the circle and pushing backward.

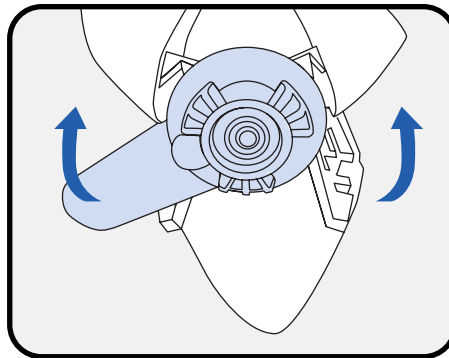
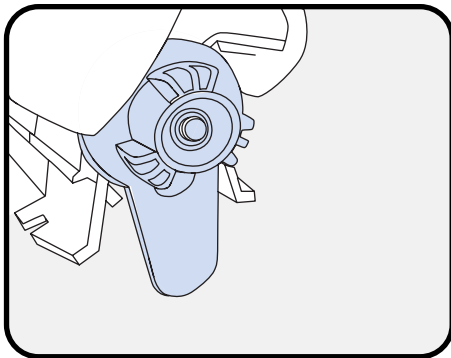

6 Slide the bridge lever, of the second fixture being attached, completely to the left or right.

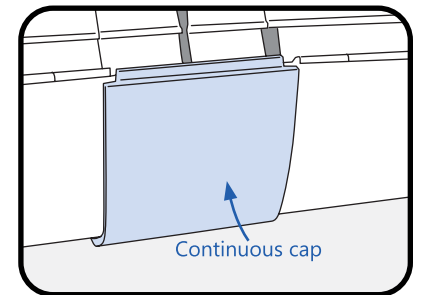
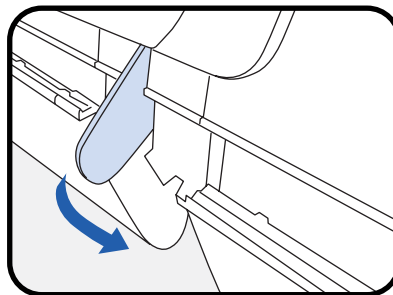
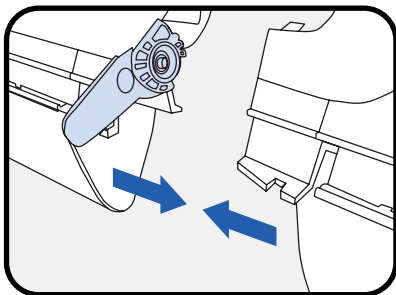

7 When the bridge lever is in the correct position, connect both fixtures by attaching the second fixture to the bridge lever of the first fixture.

8 Once both fixtures are in the correct position, slide the bridge lever downwards until it is pointing towards the floor. The fixtures are now locked together.

9 Snap on the continuous cap, provided in the kit.

NOTE: For anti-snaking adjustments turn the bridge lever slightly left or right to change the angle between the fixtures until the desired alignment is reached. The offset average is 15mm with a maximum angle of 0.4 degrees.

- 10** Pull the continuous wiring out of the first fixture to connect the power connectors of the through wiring harness. For "BC" option luminaires the second branch circuit must be continued separately from the main circuit as shown in section 10B.

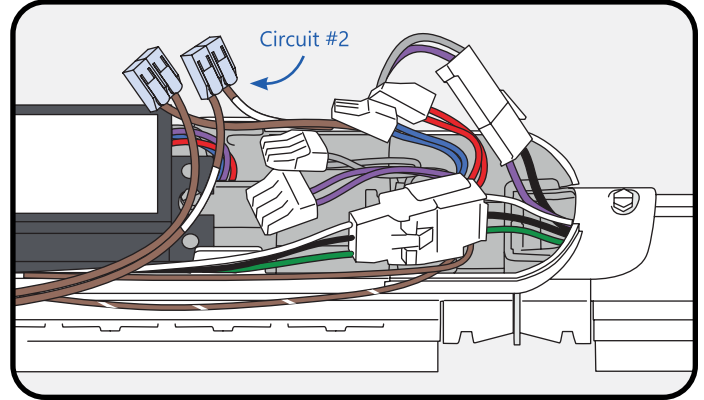
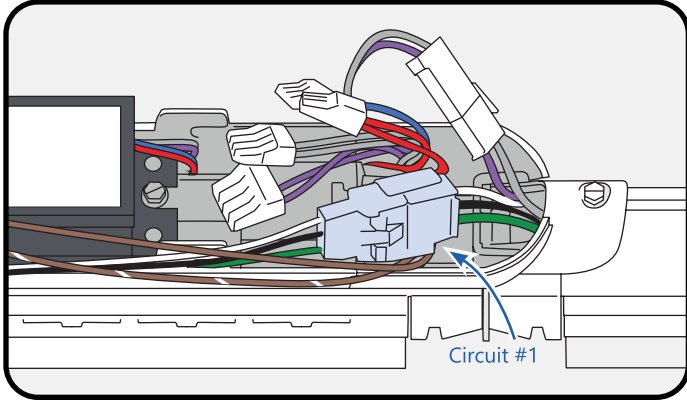

- 10a** **Circuit #1 connections:** Connect the black, white and green wires from the preceding luminaire to the same colored wire harness in the current luminaire using the quick connectors.

NOTE: All unused wires must be capped.

- 10b** **Circuit #2 connections:** Connect the brown (line) and brown/white (neutral) wires of the current luminaire's wiring harness to the similar colored wires from the preceding luminaire using the push-in connectors.

NOTE: For additional guidance, please refer to **Wiring Diagram**.

NOTE: PSU input wires in "BC" option luminaires are not connected to either branch circuit by default. Installer must select which branch to connect each luminaire to by inserting the black and white PSU wires into the appropriate branch circuit using the push-in connectors provided.

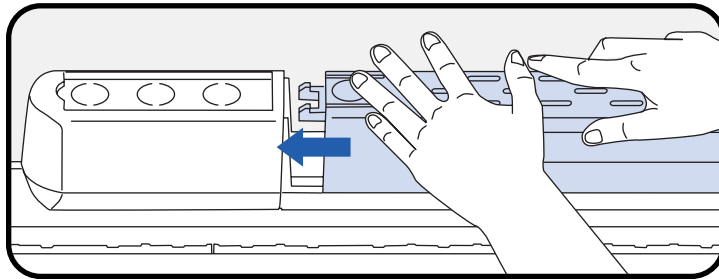

- 11** Replace the PSU cover by sliding it back into place until it clips with the previous PSU cover.

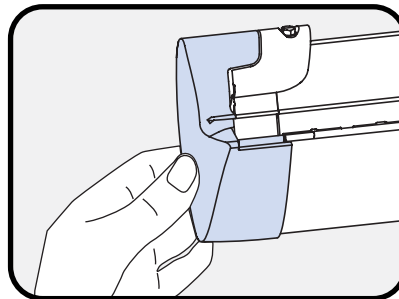
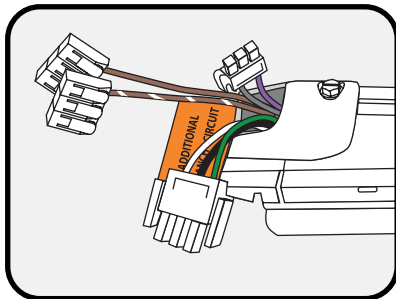

WARNING
ANY ADDITIONAL WIRES
MUST BE CAPPED OFF

- 12** Once the fixtures are attached and all wires are connected, install the end caps at both ends of the completed luminaire row, provided in the starter kit.

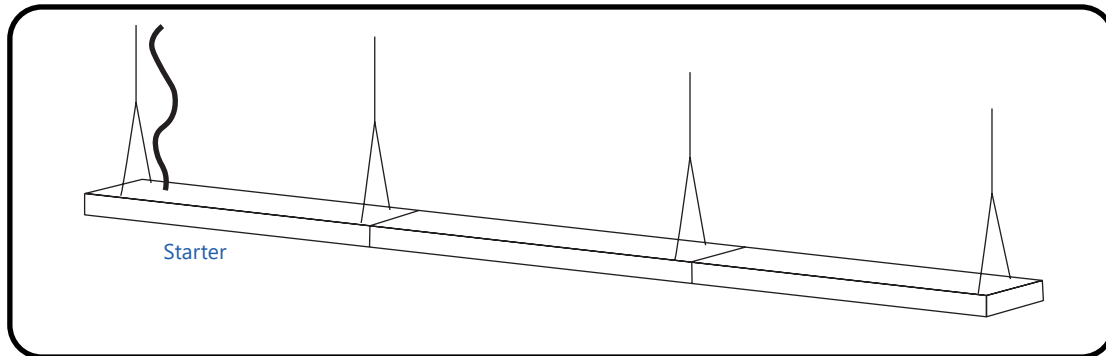

As the name implies, the Starter (if your product has such a choice) contains the beginning of the electrical connection. This means that this fixture has the only Power Drop.

The starter, when suspended, also is normally the only fixture in the row with (2) suspension hangers. The rest of the run may be suspended from a single hanger (positioned near the end where the next fixture will connect)

Installation of Wings

- 1 Follow the steps 1–6 from the previous section, Installation of Independent Luminaires.

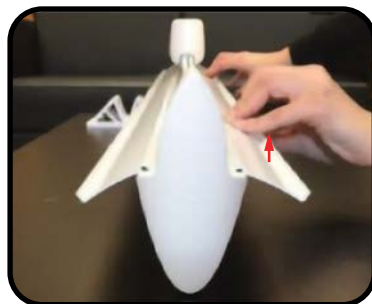
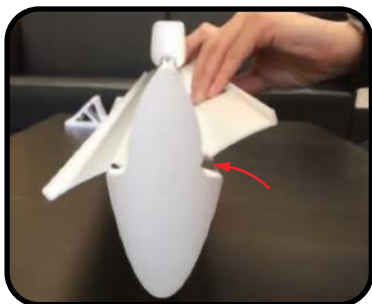

- 2 Snap the wings into place. First, wrap the wing around the reflector rails and then push them downwards. Add wings to other sides of the fixture.

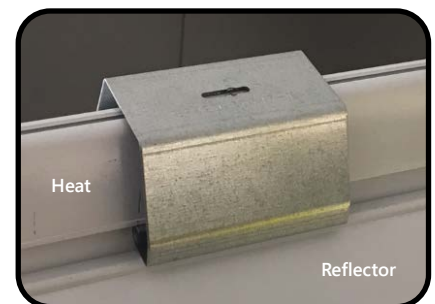

- 3 Clip the wing retention bracket, provided in the kit, on top and in the middle of the heatsink to hold the wings in place.

Replacement of Lens

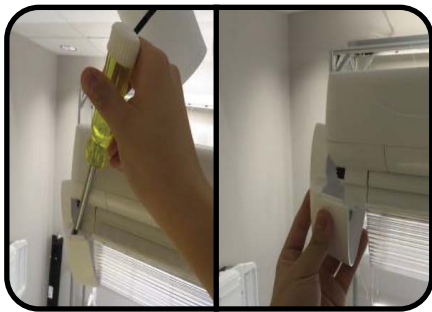

- ① Remove endcaps using a flathead screwdriver. For continuous configuration, remove interconnecting bridge.

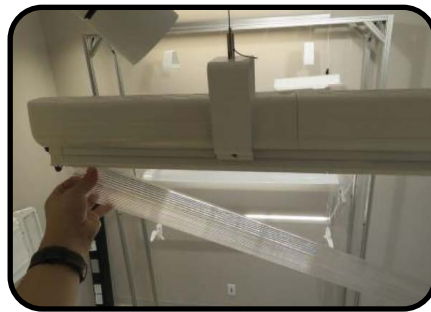

- ② Unclip old lens from light engine.



- ③ Remove replacement lens from packaging. Using a microfiber cloth, wipe down the internal cavity of the lens to remove dust particles.



- ④ Line up and clip on the lens to the light engine. Ensure that the lens is lined flush with the light engine.



- ⑤ Locate the mounting tab location. Clipping notches are located 7.5 inches apart.



- ⑥ Clip the lens into each mounting tab. Needle nose pliers can be used to clip in the lens. A click is heard when the lens is clipped into each tab. Swipe the lens by hand to ensure proper clipping.



- ⑦ Perform light up test to ensure there are no dark spots



- ⑧ Reinstall the endcaps onto the fixture. Ensure that the caps are clipped properly in place. For continuous configuration, reinstall the interconnecting bridge.

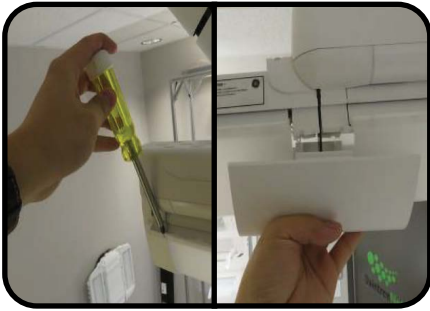

- ① Remove endcaps using a flathead screwdriver. For continuous configuration, remove interconnecting bridge.

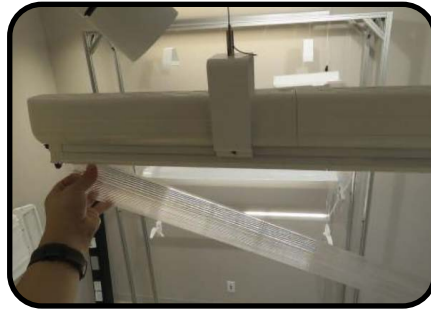

- ② Unclip old lens from light engine.

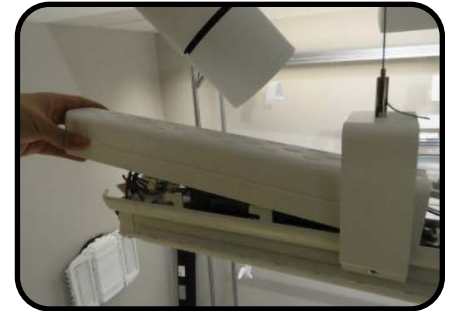

- ③ Push on tab and remove PSU cover to gain access to wires.



- ④ Disconnect DC wires from push-pin connectors. Use tweezers if needed. (Refer to **wiring diagram** on the next page if needed)

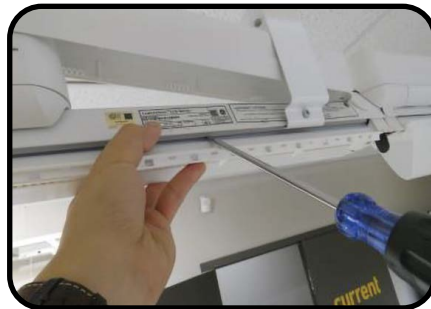

- ⑤ Using a flathead driver, pry the light engine off from the heatsink. The connection clips are located near both extremities of the fixture.



- ⑥ Remove light engine and slide out DC wires from PSU compartment. Ensure that no wires get tangled during this process.

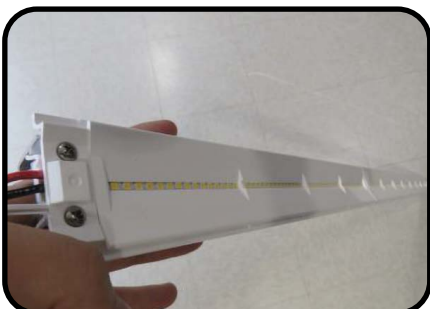

- ⑦ Carefully remove replacement light engine from packaging and perform visual inspection to ensure there is no damage.



- ⑧ Feed through the DC wires from the light engine through fixture opening to the PSU compartment.



- ⑨ Line up light engine with heatsink and mount it in place. A click should be heard when mounting light engine in place.



10 Connect DC wires of light engine to Power Supply Unit (Refer to **wiring diagram**).

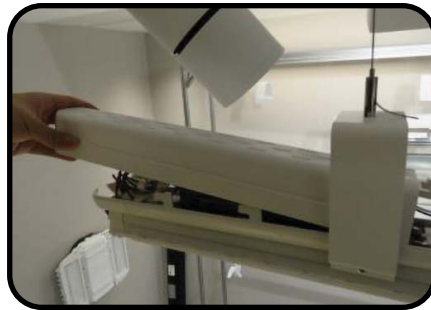

11 Ensure all wires are tucked in properly inside PSU cavity and close cover piece.



12 Re-install the lens. (Refer to **lens replacement**)



13 Re-install the endcaps onto the fixture. Ensure that the caps are clipped properly in place. For continuous configuration, re-install the interconnecting bridge.



14 Perform light up test.

Wiring Diagrams

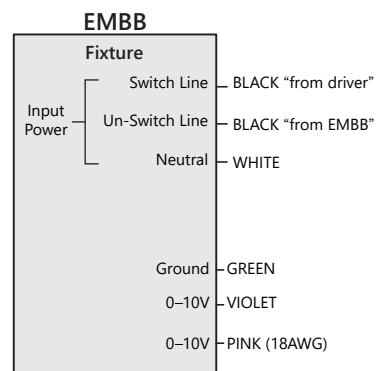
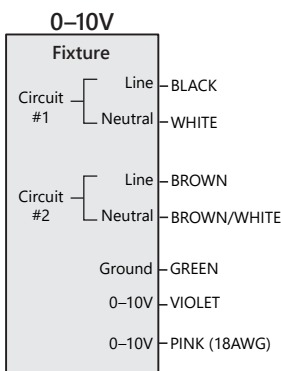
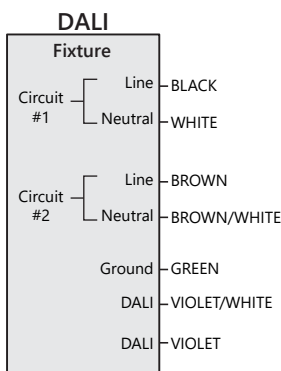



- ① Push on tab and remove PSU cover to gain access to wires.

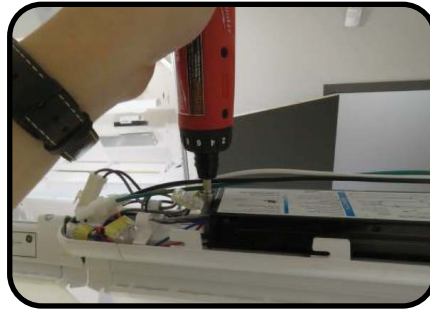

- ② Remove both Hex head #8-18 screws securing the PSU.

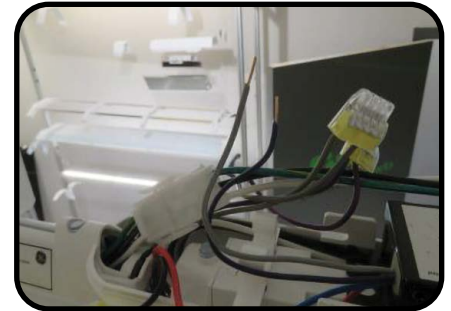

- ③ Using tweezers, disconnect dimming wires and DC wires from fixture.

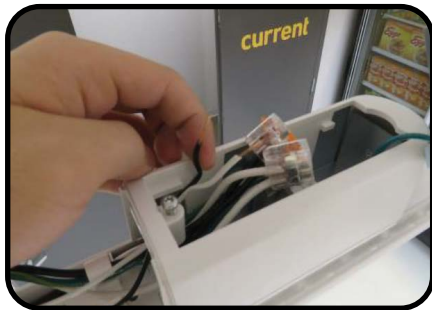

- ④ Remove knockout plate and disconnect AC wires.



- ⑤ Remove PSU from fixture. Ensure that the wires do not get tangled.



- ⑥ For EL option, or 85, A7 lumen or 84, A0, A2 lumen with 347V options, remove metal casing to gain access to driver.



- ⑦ Remove replacement PSU from packaging and perform visual inspection. Ensure that there is no damage to the wires.



- ⑧ Line up PSU and fixate using provided HEX head screws and washers.

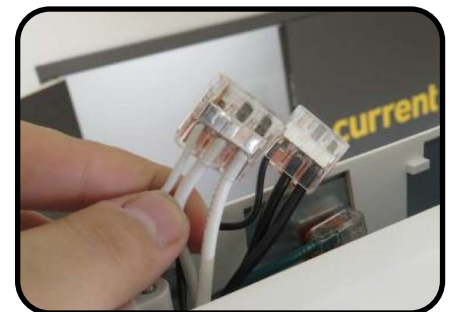

- ⑨ Connect the AC wires to the fixture's wires and close the knockout plate. (For continuous configuration, connect the dimming wires to the through wiring.) (Refer to **wiring diagram**)

Replacement of Power Supply Unit (cont.)

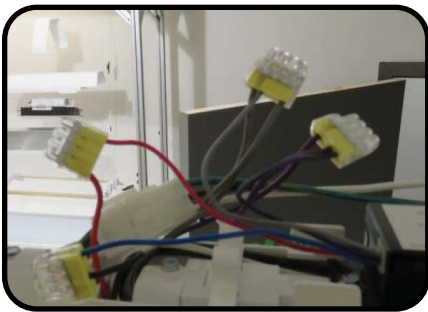

○ Connect the DC wires to the black and red wires of the



⑪ Ensure all wires are tucked in properly inside PSU cavity and



⑫

Troubleshooting

Symptom	Solution
Luminaires will not turn on	<ul style="list-style-type: none"> • Check that the color of the supply side wires match the color of the wires they are connected to. • Check that all wire connectors are properly connected. • Verify that the input voltage is within specs. • If you are using any additional controls (i.e. dimming wires, motion sensors), please also verify that those are working properly and that the unit is setup to interface with the controllers.
Luminaire on through wiring will not turn on	<ul style="list-style-type: none"> • Check that the through wiring connector from the previous fixture in the linear row is fully engaged to the malfunctioning luminaire.
Continuous Luminaire run not leveled	<ul style="list-style-type: none"> • Reposition the suspension brackets as close to the end of the fixture as possible.

This device complies with Part 15 of the FCC Rules. Operation is subject to the following two conditions: (1)This device may not cause harmful interference, and (2)this device must accept any interference received, including interference that may cause undesired operation. This Class [A] RFLD complies with the Canadian standard ICES-005. Ce DEFR de la classe [A]est conforme à la NMB-005 du Canada.

Note: This equipment has been tested and found to comply with the limits for a Class A digital device, pursuant to part 15 of the FCC Rules. These limits are designed to provide reasonable protection against harmful interference when the equipment is operated in a commercial environment. This equipment generates, uses, and can radiate radio frequency energy and, if not installed and used in accordance with the instruction manual, may cause harmful interference to radio communications. Operation of this equipment in a residential area is likely to cause harmful interference in which case the user will be required to correct the interference at his own expense.