

# Contour LS

## LED Lighting System

GEXNLBL-1, GEXNLGL-1, GEXNLRD-1,  
GEXNL65-1, GEXNL32-1

24  
Volt

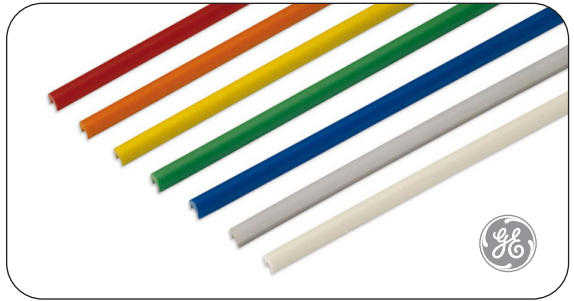

### BEFORE YOU BEGIN

Read these instructions completely and carefully.

### ⚠ WARNING / AVERTISSEMENT

#### RISK OF ELECTRIC SHOCK

- Turn power off before inspection, installation or removal.
- Properly ground power supply enclosure.

#### RISK OF FIRE

- Use only UL approved wire for input/output connections. Minimum size 18 AWG (0.82mm<sup>2</sup>)
- Follow all NEC and local codes.
- Not to be submerged or used in a marine environment.

#### RISK OF FIRE OR ELECTRIC SHOCK

- LED Retrofit Kit installation requires knowledge of sign electrical systems. If not qualified, do not attempt installation. Contact a qualified electrician.
- Install this kit only in host signs that have been identified in the installation instructions and where the input rating of the retrofit kit does not exceed the input rating of the sign.
- Installation of this LED retrofit kit may involve drilling or punching of holes into the structure of the sign. Check for enclosed wiring and components to avoid damage to wiring and electrical parts.
- Do not make or alter any open holes in an enclosure of wiring or electrical components during kit installation.

#### RISQUES DE DÉCHARGES ÉLECTRIQUES

- Coupez l'alimentation avant l'inspection, l'installation ou le déplacement.
- Assurez-vous de correctement mettre à terre l'alimentation électrique.

#### RISQUES D'INCENDIE

- N'utilisez que des fils approuvés par UL pour les entrées/sorties de connexion. Taille minimum 18 AWG (0.82mm<sup>2</sup>)
- Respectez tous les codes NEC et codes locaux.
- Ne pas submerger ou installer dans un environnement marin.

#### RISQUE D'INCENDIE OU DE CHOC ÉLECTRIQUE

- L'installation de l'équipement de remplacement DEL exige la connaissance des systèmes électriques pour enseignes. Si non qualifié, ne tentez pas d'installation. Veuillez contacter un électricien qualifié.
- Risque d'incendie ou de choc Électrique. Installez cet ensemble seulement dans des enseignes hôtes qui ont été identifiés dans les instructions d'installation et dont la capacité d'entrée de l'ensemble ne dépasse pas la capacité d'entrée de l'enseigne.
- L'installation de cet équipement de remplacement DEL peut impliquer le perçage ou le poinçonnage de trous dans la structure du panneau Vérifiez le câblage et les composants inclus pour éviter d'endommager le câblage et les composants électriques.
- Ne pas faire ou modifier les trous ouverts dans une enceinte de câblage ou de composants électriques pendant l'installation de cet équipement de remplacement DEL.

- Outdoor installations require waterproofing of wire connections. See instructions for details.
- Avoid prolonged exposure to standing water or ice.

## Prepare Electrical Wiring



### Electrical Requirements

- Acceptable to use in dry, damp and wet locations when installed correctly.
- The grounding and bonding of the LED Driver shall be done in accordance with National Electric Code (NEC) Article 600.
- Follow all National Electric Codes (NEC) and local codes.
- These products are only suitable for connection to a circuit from a Class 2 power source.
- These products have not been evaluated for use when connected to a power source that does not comply with Class 2 voltage and energy limited supplies.

## Save These Instructions

Use only in the manner intended by the manufacturer. If you have any questions, contact the manufacturer.



RETROFIT SIGN CONVERSION LED KIT FOR USE ONLY IN ACCORDANCE WITH KIT INSTRUCTIONS. KIT IS COMPLETE ONLY WHEN ALL PARTS REQUIRED BY THE INSTRUCTIONS ARE PRESENT. TROUSSE DE CONVERSION À DEL POUR LA MODERNISATION DES ENSEIGNES À UTILISER CONFORMÉMENT AU GUIDE D'INSTALLATION.

This device complies with part 15 of the FCC Rules. Operation is subject to the following two conditions: (1) This device may not cause harmful interference, and (2) this device must accept any interference received, including interference that may cause undesired operation.

Note: This equipment has been tested and found to comply with the limits for a Class A digital device, pursuant to part 15 of the FCC Rules. These limits are designed to provide reasonable protection against harmful interference when the equipment is operated in a commercial environment. This equipment generates, uses, and can radiate radio frequency energy and, if not installed and used in accordance with the instruction manual, may cause harmful interference to radio communications. Operation of this equipment in a residential area is likely to cause harmful interference in which case the user will be required to correct the interference at his own expense.

This Class [A] RFLD complies with the Canadian standard ICES-005. Ce DEFR de la classe [A] est conforme à la NMB-005 du Canada.

If you have any questions about these instructions or your specific application, please contact support at [tetra.support@LED.com](mailto:tetra.support@LED.com). For the latest install guides for your product go to: [www.LED.com/tetra](http://www.LED.com/tetra)

This product is intended solely for the use of non-residential signage lighting and is not intended for use in any other applications. Conforms to the following standards:



Note: "CE" and "UKCA" applies to models GEXNLRD-1, GEXNLBL-1, and GEXNLGL-1 only.



Electrical products must not be thrown out with domestic waste. They must be taken to a communal collecting point for environmentally friendly disposal in accordance with local regulations. Contact your local authorities or stockist for advice on recycling. The packaging material is recyclable. Dispose of the packaging in an environmentally friendly manner and make it available for the recyclable material collection-service.

## Components and Tools Required

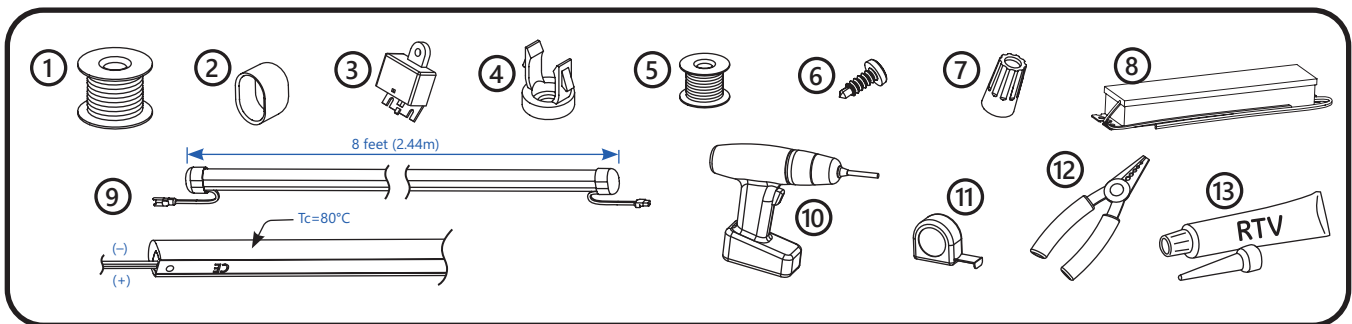

- ① UL approved 18 AWG (0.82mm<sup>2</sup>) supply wire
- ② Tetra® End Caps
- ③ Weather boxes
- ④ Light Guide Mounting Clips
- ⑤ 22 AWG (0.33mm<sup>2</sup>) tie-wire
- ⑥ #6, #8 or #10 (M2, M3 or M4) self drilling pan headed screws
- ⑦ UL approved 22-14 AWG (0.33-2.08mm<sup>2</sup>) twist-on wire connectors
- ⑧ 24 Volt power supply
- ⑨ Tetra® Contour LS
- ⑩ Cordless drill
- ⑪ Tape measure
- ⑫ Wire stripper/cutter

- ⑬ Electrical grade silicone.

**Examples of electrical grade silicone:**

- Momentive RTV 6700 Series Silicone Rubber Adhesive Sealant
- Momentive White Blanc RTV 162 Silicone Rubber Adhesive Sealant-Electrical Grade
- Dow Corning 3140 - Non-Corrosive Flowable (clear)
- Dow Corning 3145 - Non-Corrosive Nonflowable (clear or gray)
- Dow Corning RTV 748 Non-Corrosive Sealant-White

⑭ **Cutting Resolution Table**

Light Engine Color	Color	Cutting Resolution
GEXNLRD-1	Red	8 in. (203 mm)
GEXNLGL-1	Green	8 in. (203 mm)
GEXNLBL-1	Blue	8 in. (203 mm)
GEXNL65-1	White	8 in. (203 mm)
GEXNL32-1	Warm White	8 in. (203 mm)

## Planning First

**NOTE:** For planning the layout, measure the perimeter of the building and divide by 8 ft. (2.44m) to determine the required quantity of Tetra Contour LS systems. See cutting resolution table on page 2 for guidelines when cutting any Tetra Contour LS sections. For seamless designs, accessories are available for straight runs and 90 degree corners.

**NOTE:** Do not use more than one suffix code for each respective application, as mixing suffix codes may result in appearance variation. Suffix code can be found on the packaging label.

**NOTE:** Tetra Contour LS systems cannot be bent. Use only for straight runs.

Installation

METHOD A - Installing Tetra Contour LS - Straight Runs Only

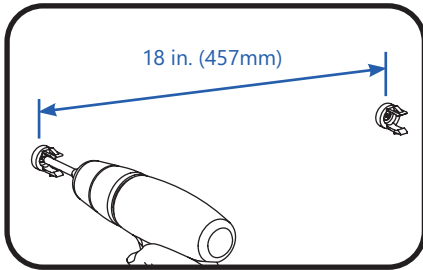

1 Install one mounting clip at each end and then a minimum of one mounting clip every 18 inches (457mm).

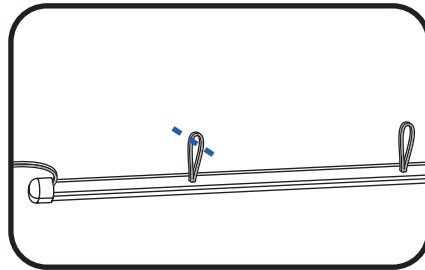

2 If required, using a sharp cutting tool, cut wire loops between sections (refer to the Cutting Resolution Table on page 2). Remove light engine from light guide and cut light guide to desired length.

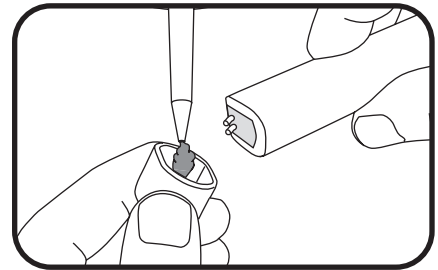

3 For cut end, fill cap with electrical grade silicone and push cap on the end to seal. Clean excess silicone.

**CAUTION**  
**Risk of damage.** Must use electrical grade silicone.

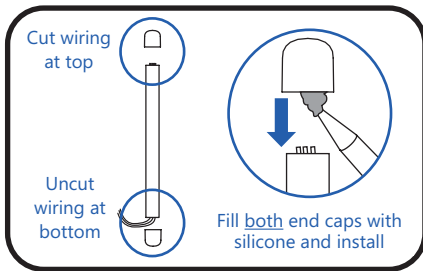

4 For vertical or near vertical installations, we recommend designing such that any cut-end termination of a Contour piece resides at the top of the design.

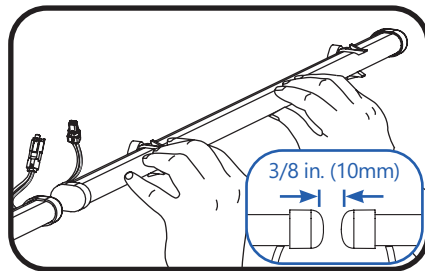

5 Continue attaching all the sections to the remaining mounting clips, leaving a 3/8 inch (10mm) gap between sections to allow for expansion or contraction.

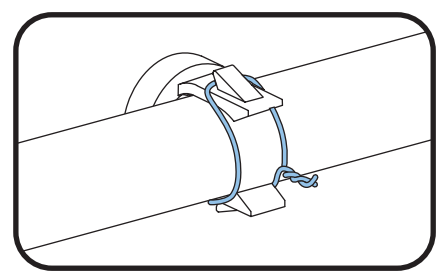

6 Secure light guide by twisting tie-wire around the mounting clip and light guide.

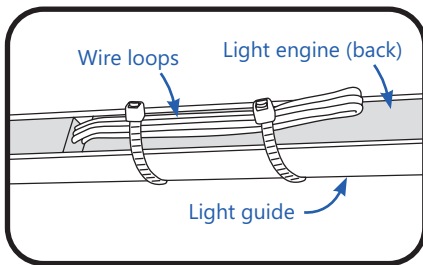

7 Wires between light guide segments can be folded behind the light guide and attached with clear zip ties.  
**NOTE:** Zip ties should wrap around outside light guide.

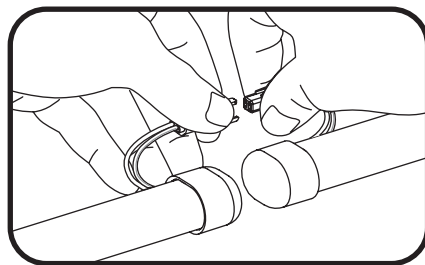

8 Plug together all adjacent Tetra Contour LS sections and tuck wires behind.

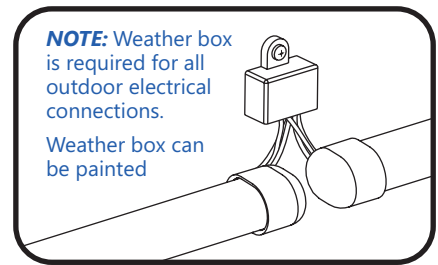

9 Insert wire connectors into weather box. Fill with electrical grade silicone and close box. Weather box can be mounted using #8 (M3) screws.  
**NOTE:** Weather box is required for all outdoor electrical connections.

## Joining with Light Guide Connectors, Corners and Bends

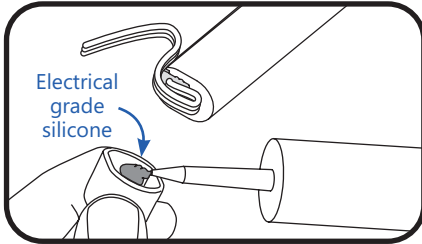

- ⑩ For uncut end, fold wire over Tetra Contour. Fill the end cap with silicone and push cap on the end to secure. Clean excess silicone.

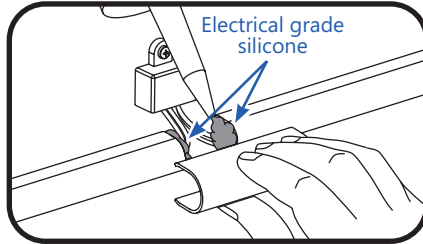

- ⑪ Linear: At each gap between sections, apply silicone on both sides to secure light guide connector. Snap on a light guide connector.

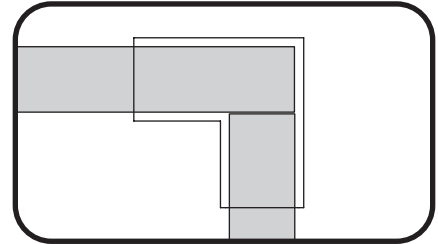

- ⑫ Corner: For all corners (planar, inside, outside) insert first light guide all the way into the corner connector. Then insert the second light guide up to the first one.

## Electrical Connections

**NOTE:** Do not use connectors pre-filled with silicone grease/mineral base protective grease or use silicone grease to seal connections.

### ⚠ WARNING

**Risk of electrical shock.** Turn power OFF before inspection, installation or removal.

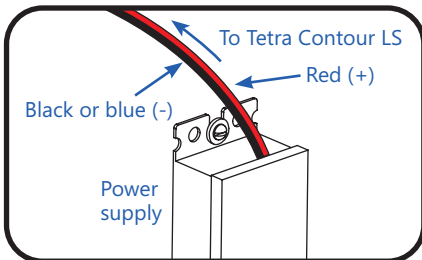

- ⑬ Run a wire from the power supply to a section of Tetra Contour LS.  
**NOTE:** Power supply connection must be contained in an acceptable UL/NEMA enclosure.  
**NOTE:** Power supply loading is described in the power supply installation instructions.

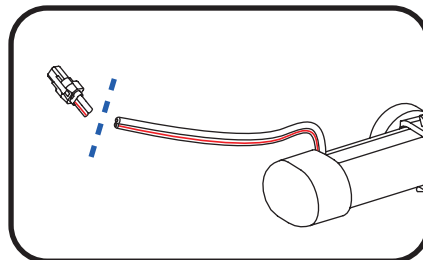

- ⑭ Cut off the quick connector on the Tetra Contour LS that you are connecting to the power supply.

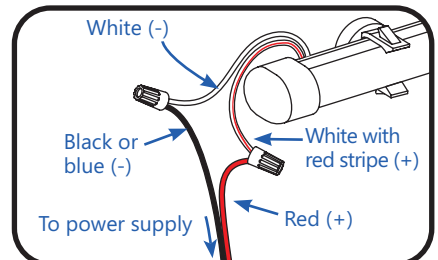

- ⑮ Using twist-on wire connectors, connect the white wire with red stripe (+) from the LED strip to the red wire (+) of the power supply. Connect the white wire (-) from the LED strip to the black or blue wire (-) of the power supply.  
**NOTE:** Grounding and bonding must be done in accordance with National Electrical Code (Article 600). See power supply instructions.

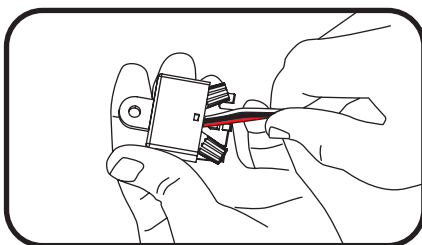

- ⑯ Insert wire connectors into weather box. Fill with electrical grade silicone and close box.

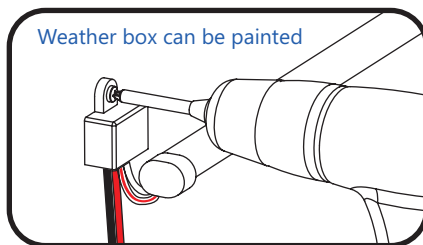

- ⑰ Secure the weather box using a #6 or #8 (M2 or M3) screw.  
**NOTE:** When using twist-on connectors, weather box is required for all outdoor electrical connections.

**NOTE:** All electrical connections should be suitably protected from mechanical damage and the environment. Seal all connections in locations that may be exposed to water with electrical grade RTV silicone.

## METHOD B - Attaching Tetra Contour LS to Tetra Contour

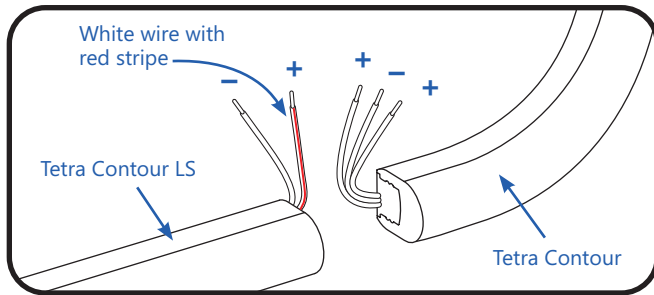

- 1 Tetra Contour LS can be connected to formable Tetra Contour for custom shapes. Separate wires and identify conductors as positive (+) and negative (-). Strip ends back 0.5 in. (13mm).

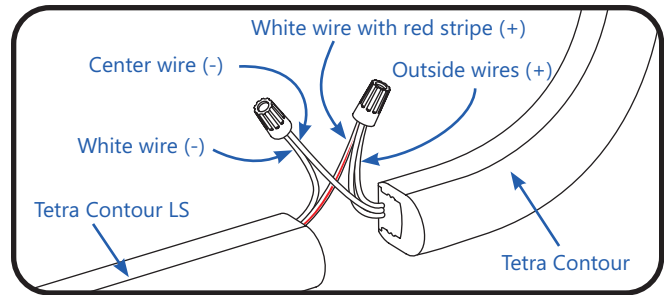

- 2 Splice the white wire with red stripe (+) of Tetra Contour LS to the two outside wires (+) of Tetra Contour and splice the white wire (-) of Tetra Contour LS to the center wire (-) of Tetra Contour. Insert wire connectors into weather box. Fill with electrical grade silicone and close box.

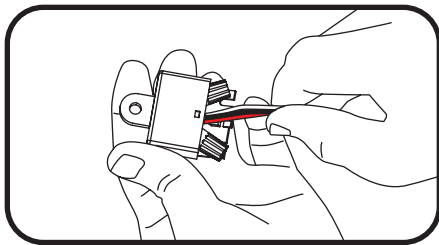

- 3 Insert wire connectors into weather box. Fill with electrical grade silicone and close box.

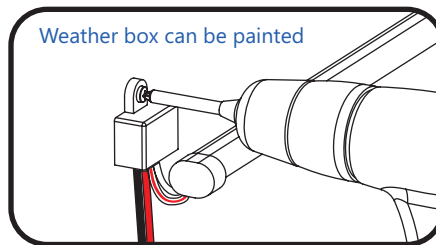

- 4 Secure the weather box using a #6 or #8 (M2 or M3) screw.

**NOTE:** When using twist-on connectors, weather box is required for all outdoor electrical connections.

**NOTE:** For assembling accessories like connectors and corners, see Page 4.

## Retrofit Instructions

1. **(Existing Signs Only)** Prior to installation, survey the site for information regarding power and accessibility inside and outside the building. Ensure that the branch circuit supplying the existing transformer or ballast will be within the voltage ratings of the new LED power supply, and have a current rating not exceeding 20A, or that permitted by applicable local, state, or country electrical codes (whichever is less).
2. **(Existing Signs Only)** Remove the existing lighting equipment to be replaced, such as neon tubing or fluorescent tubes; and associated transformers and ballasts. Care should be taken not to break the existing neon or fluorescent tubes.  
**NOTE:** Follow all federal and local regulations when disposing of neon tubing, fluorescent tubes, transformers and ballasts.
3. **(Existing Signs Only)** If removal of the existing lighting equipment eliminates the disconnect switch, as required by applicable local, state, or country electrical codes; a new disconnect switch must be installed.
4. **(Existing Signs Only)** Repair and seal any unused openings in the electrical enclosure. Openings greater than 12.7-mm (1/2-in) diameter require a metal patch secured by screws or rivets and caulked with non-hardening caulk. Smaller openings may be sealed with non-hardening caulk.
5. Using the layout guidelines above, determine required number of LED modules required to illuminate the sign.
6. A 24VDC Class 2 Power Supply, as listed below, must be used with this retrofit kit. Determine the number of Power Supplies required to power the number of LED modules required to illuminate the sign, so as not to overload the Power Supply chosen.
7. Follow method A or B to mount the Tetra Contour LS.
8. Connect the DC output of the power supply to the LED modules using the Electrical Connections instructions above.
9. Connect the power unit to the supply in accordance with the applicable local, state, and country electrical codes, and the instructions found in the power supply installation guide.
10. If required, the disconnect switch shall be installed by qualified personnel, in accordance with applicable local, state, and country electrical codes.

## Troubleshooting

Symptom	Solution
All LEDs are OFF	<ul style="list-style-type: none"> <li>• Check AC input connection and/or check circuit breaker</li> <li>• Check wire connection(s) at the Tetra Contour LS section and power supply for improper termination(s) or short circuits. Properly terminate or replace the wire connection(s).</li> <li>• Check that connections are the white wire with red stripe (+) of the LED strip to the red wire (+) of the power supply and the white wire (-) of the LED strip to the black or blue wire (-) of the power supply.</li> </ul>
Some LEDs appear dim	<ul style="list-style-type: none"> <li>• Ensure the overall length of the Tetra Contour LS does not exceed the maximum load.</li> <li>• Ensure the length of supply wire is equal to or below the recommended remote mounting distance.</li> <li>• Make sure that all LED light engines have the same suffix code (suffix code is located on the box label).</li> </ul>
Some of the sections are not illuminated	<ul style="list-style-type: none"> <li>• Check wire connection(s) at the Tetra Contour LS section and power supply for improper termination(s) or short circuits. Properly terminate or replace the wire connection(s).</li> <li>• Check that connections are the white wire with red stripe (+) of the LED strip to the red wire (+) of the power supply and the white wire (-) of the LED strip to the black or blue wire (-) of the power supply.</li> </ul>

## Maximum Loading per 24 VDC Class 2 Power Supply

Power Supply	GEXNLRD-1	GEXNLBL-1, GEXNLGL-1	GEXNL65-1, GEXNL32-1
<b>Rating per module</b>	24VDC, 1.30W/ft. (Strip) 1.53W/ft. (System)	24VDC, 1.73W/ft. (Strip) 2.03W/ft. (System)	24VDC, 3.17W/ft. (Strip) 3.73W/ft. (System)
<b>GEPS24-25U-NA</b> <i>Load shall not exceed 1.04A</i>	16 ft. (4.88 m)	12 ft. (3.66 m)	6 ft. (1.83 m)
<b>GEPS24D-60U-GLX, *GELP24-60U-GL</b> <i>Load shall not exceed 2.5A</i>	42 ft. (12.80 m)	31 ft. (9.44 m)	17 ft. (5.18 m)
<b>GEPS24D-80U, GEPS24W-80</b> <i>Load shall not exceed 3.3A</i>	58 ft. (17.68 m)	44 ft. (13.41 m)	24 ft. (7.3 m)
<b>GEPS24-100U-GLX, GEPS24D-100U-NA, GEPS24LT-100U-NA, USVI-100024FBA, USVI-100024FE, GEPS24-100U-GLX2/TT, **GEPS24V50-100W</b> <i>Load shall not exceed 4.0A</i>	69 ft. (21m)	52 ft. (15.85 m)	29 ft. (8.8 m)
<b>GEPS24-180U</b> <i>Load shall not exceed 3.8A per each (of 2) banks</i>	65 ft. (19.81 m) per bank 130 ft. (39.62 m) per PS	48 ft. (14.63 m) per bank 96 ft. (29.26 m) per PS	27 ft. (8.2 m) per bank 54 ft. (16.4 m) per PS
<b>GEPS24-200U-GLX2</b> <i>Load shall not exceed 4.0A per each (of 2) banks</i>	69 ft. (19.81 m) per bank 138 ft. (42.06 m) per PS	52 ft. (15.85 m) per bank 104 ft. (31.70 m) per PS	29 ft. (8.8 m) per bank 58 ft. (17.6 m) per PS
<b>GEPS24-300U-GLX2</b> <i>Load shall not exceed 4.0A per each (of 3) banks</i>	69 ft. (21 m) per bank 207 ft. (63 m) per PS	52 ft. (15.8 m) per bank 156 ft. (47.5 m) per PS	29 ft. (8.8 m) per bank 87 ft. (26.5 m) per PS

\*GELP24-60U-GL minimum load = 16 ft. (4.87 m) for GEXNLRD-1; 12 ft. (3.65 m) for GEXNLBL-1 and GEXNLGL-1; or 7 ft. (2.13 m) for GEXNL65-1 and GEXNL32-1

\*\*GEPS24V50-100W minimum load = 33 ft. (10.06 m) for GEXNLRD-1; 25 ft. (7.62 m) for GEXNLBL-1 and GEXNLGL-1; or 14 ft. (4.27 m) for GEXNL65-1 and GEXNL32-1

## Maximum Remote Mounting Distance

Power Supply Wattage	18 AWG/0.82 mm <sup>2</sup> Supply Wire	16 AWG/1.31 mm <sup>2</sup> Supply Wire	14 AWG/2.08 mm <sup>2</sup> Supply Wire	12 AWG/3.31 mm <sup>2</sup> Supply Wire
25W	20 ft./6.1 m	–	–	–
60W, 80W, 100W, 180W, 200W, 300W	20 ft./6.1 m	30 ft./9.1 m	50 ft./15.2 m	86 ft./26.1 m