

CB-LED



CB-LED Compact Bollard Replacement Kit Instructions



WARNING: Fixtures must be grounded in accordance with local codes or the National Electrical Code. Failure to do so may result in serious personal injury.

NOTE: All wiring must be done by a qualified electrician.

KEEP THIS SHEET FOR FUTURE REFERENCE.



Make certain electrical supply is **OFF** before replacing LED components.



Assurez-vous que l'alimentation électrique est éteint avant de remplacer des composants LED.

Parts List:

LED Kit (includes driver and LED modules)

Tools Required:

- 3/16" Allen Wrench
- 9/16" Wrench
- Narrow Flat Blade Screwdriver

1. Undo latch and cover hook to remove top cap.
2. Loosen (4) 8-32 screws to remove center louver and ribbed globe.
3. Loosen (4) 8-32 screws to remove fixture base.
4. Disconnect LED assembly wiring harness from driver wiring harness.
5. Remove screws holding LED heat sink to fixture base, and swap out with replacement LED assembly.
6. Disconnect driver wiring harness from line voltage.
7. Remove screws holding electronic driver assembly to mounting plate and swap out with replacement electronic driver assembly.
8. Reverse steps to reassemble bollard.
9. NOTE: Align thru holes in base casting with 4 mounting slots in heatsink.
10. NOTE: Heatsinks to be installed so that "T" indicator mark is facing up.

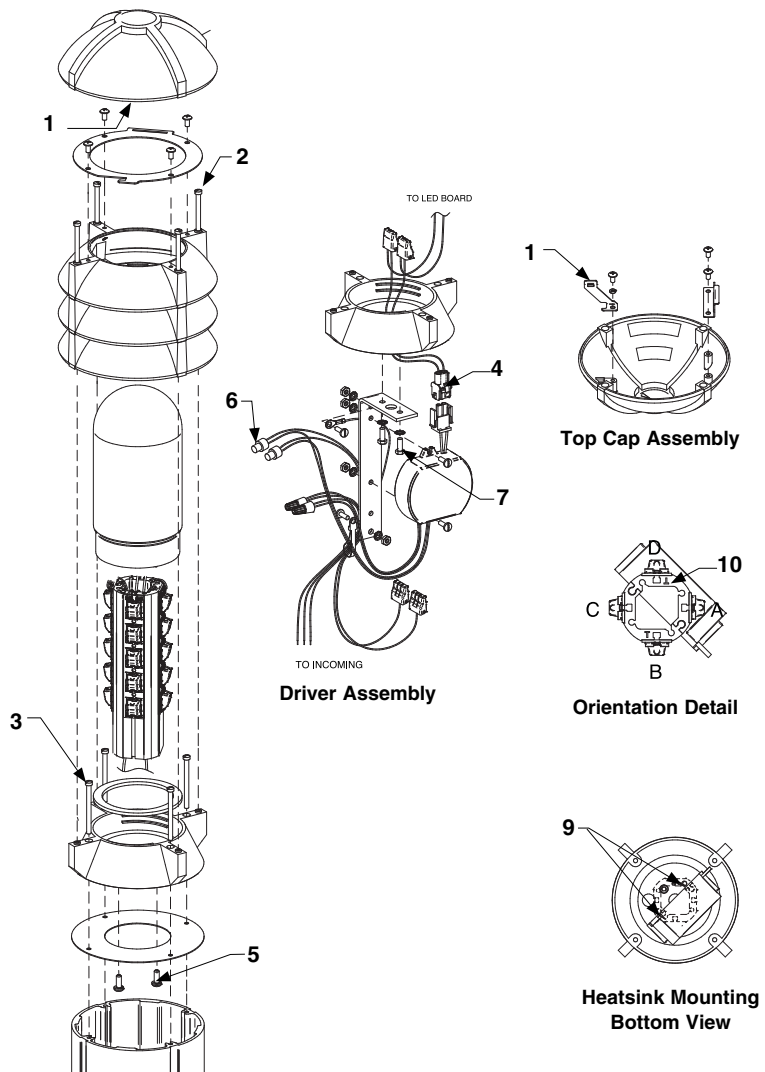

CB-LED Compact Bollard Replacement Kit Instructions

WIRING DIAGRAM

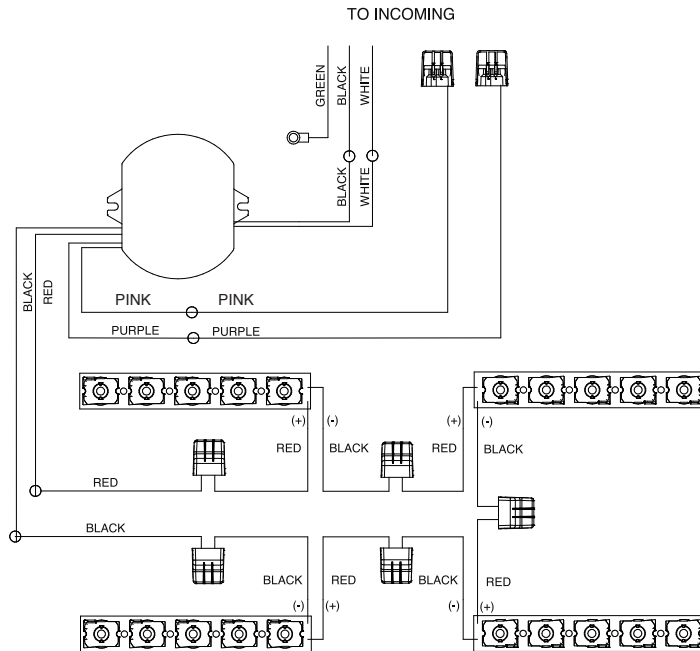

WIRING DIAGRAM

0-10V Dimming















Driver has a 0-10V dimming interface with a dimming range of 10-100%. Is compatible with most control systems. Approved dimmers include Lutron Diva AVTV, Lutron Nova NFTV and NTFTV. Note: Not compatible with current sourcing dimmers. Controls compatible via Pink and Purple dimming lead.

Battery Backup







If your fixture includes Battery Backup Option, an additional power wire is included labeled "Unswitched Power". This lead must be connected to an unswitched power source running 120-277 VAC to function properly.

CB-LED Compact Bollard Replacement Kit Instructions

Installation warnings and cautions for upgrade kits Avertissements et précautions pour l'installation de kits de mise à niveau.

-  **WARNING:** Make certain all electrical supply is OFF before starting installation or beginning maintenance procedures.
-  **AVERTISSEMENT:** S'assurer que toute alimentation possible est COUPÉE avant de commencer l'installation ou l'entretien.
-  **WARNING:** Fixtures must be grounded in accordance with local codes or the National Electrical Code. Failure to do so may result in serious personal injury.
-  **AVERTISSEMENT:** Les appareils doivent être mis à la terre en conformité avec le Code canadien de l'électricité et les codes locaux. Une non-conformité pourrait conduire à des blessures graves.
-  **WARNING:** To prevent wiring damage or abrasion, do not expose wiring to edges of sheet metal or other sharp objects.
-  **AVERTISSEMENT:** Pour empêcher l'endommagement ou l'éraflure des fils, empêchez tout contact avec les rebords des parties métalliques.
-  **MAINTENANCE:** A regularly scheduled maintenance program should be established to retain optimum light output and reduce heat retention. Dusting with a soft, clean, dry cloth is normally sufficient for the reflector.
-  **ENTRETIEN:** Un programme d'entretien régulier devrait être établi pour conserver la luminosité optimale et réduire l'accumulation de chaleur. Un chiffon doux et propre est normalement suffisant pour dépoussiérer le réflecteur optique.
-  **NOTE:** All wiring must be done by a qualified electrician.
-  **REMARQUE:** Tout le câblage doit être fait par un électricien certifié.
-  **CAUTION:** LED fixtures are available in 120 volt input or 277volt input. Please verify before wiring fixture to field wires. (see lamp label to verify).
-  **MISE EN GARDE:** Les appareils d'éclairage à DEL sont offerts pour alimentation à 120 V ou 277 V. Veuillez vérifier avant de raccorder (voir l'étiquette de l'appareil pour confirmer).
-  **WARNING: RISK OF FIRE OR ELECTRICAL SHOCK.** Install this kit only in the luminaires that have the construction features and dimensions shown in the photographs and/or drawings. Luminaires wiring, power supply, or other electrical parts may be damaged when drilling for installation of retrofit assembly hardware. Inspect all wiring and components for damage.
-  **AVERTISSEMENT: DANGER DE CHOC ÉLECTRIQUE OU D'INCENDIE.** N'installez cette trousse que sur les luminaires qui sont construits pour l'accepter et qui ont les dimensions montrées sur les photographies et/ou dessins. Il y

a risque d'endommagement du câblage, du bloc d'alimentation ou d'autres parties lors du perçage pour installer la quincaillerie pour modification. Vérifiez qu'aucun dommage aux fils ou composants n'a été fait.

-  **CAUTION:** Unless otherwise specified, do not make or alter any openings in the compartment of wiring or electrical components during installation of this retrofit assembly. Plug all unused openings in the compartment of wiring or electrical components.
-  **ATTENTION:** Pour cette modification, ne pas percer ou modifier toute ouverture du compartiment de connexion des câbles ou celui des composants électriques sauf si clairement indiqué dans une autre directive. Bouchez toutes les ouvertures du compartiment de connexion ou des composants électriques qui ne sont pas utilisées.
-  **CAUTION:** Only the holes indicated in the photographs and/or drawings may be made or altered as a result of kit installation. Do not leave any other open holes in an enclosure of wiring or electrical components.
-  **ATTENTION:** Seuls les trous indiqués dans les photographies et/ou les dessins peuvent être percés ou modifiés pour installer la présente tousse. Les compartiments de connexion ou des composants électriques ne doivent comprendre aucune ouverture non obstruée autre que celles requises au câblage.
-  **CAUTION:** Installation of this retrofit assembly requires a person familiar with the construction and operation of LED luminaire electrical systems and the hazards involved
-  **ATTENTION:** installation de ce nécessaire de modernisation a une personne connaissant la construction et le fonctionnement des installations d'éclairage fluorescent et consciente des risques qu'elles comportent.
-  **CAUTION:** Do not alter, relocate, or remove wiring, lampholders, ballasts, or any other electrical components.
-  **ATTENTION:** Ne pas modifier, déplacer ni enlever de câble, de douille de lampe, de ballast ou autre composant électrique.
-  **WARNING:** The H.I.D./Fluorescent fixtures utilizes a lamp that may contain mercury. For information on disposal of lamp go to website: www.lamprecycle.org.
-  **AVERTISSEMENT:** Les appareils d'éclairage à décharge à haute intensité ou à fluorescents peuvent contenir du mercure. Pour l'information de disposition des ampoules/tubes, visitez le site Web: www.lamprecycle.org.
- CONSERVER LA PRÉSENTE FEUILLE POUR RÉFÉRENCE ULTÉRIEURE.**
- KEEP THIS SHEET FOR FUTURE REFERENCE.**