

In-grade luminaires often become ineffective or inoperable simply because they are not installed and maintained correctly. While it is tempting to install these fixtures at or below grade, this generally turns out to be unsatisfactory unless the installation is in a paved area. When the fixtures are installed too low, they become a

collection point for dirt, mud and encroaching ground cover. With a little pre planning and care, below-grade luminaires can be installed in a manner that will promote easy maintenance and longevity. The following installation methods represent our best recommendations.

INSTALLATION GUIDELINES:

Remember, **always isolate and elevate.**



CAUTION

All conduit connections **must be sealed Per 2011 NEC 300.5 (G)** in order for the Pour box to remain dry! (sealant not supplied.)

CREATE A BUFFER ZONE:

When the fixtures are to be installed in areas planted in ground cover and shrubbery, a buffer zone is needed to prevent lens overgrowth as the plants mature. Elevating the fixture will encourage water runoff around the unit rather than over the top.

Advantages of a buffer zone:

- Helps prevent lens overgrowth.
- Provides a defined edge for trimming.
- Provides drainage around fixture and helps keep the lens clean.
- Rock-fill partially buffers fixture from corrosive soil and improves ground drainage.
- Visually looks like a flush mounted installation.

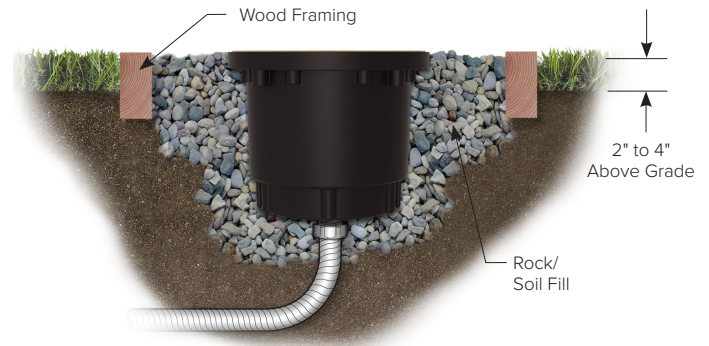

INSTALL IN CONCRETE:

Another option for ground cover, shrubbery or lawn areas is to encase the fixture in concrete. This has some additional advantages over the rock-fill method (above).

Advantages of concrete installation:

- Allows higher wattage lamps because concrete makes an excellent heat sink.
- Totally isolates fixture from corrosive soils.
- Helps prevent lens overgrowth.
- Allows edging without scratching fixture.
- Provides drainage around fixture and helps keep the lens clean.
- Rock-fill partially buffers fixture from corrosive soil and improves ground drainage.
- Visually looks like a flush mounted installation.

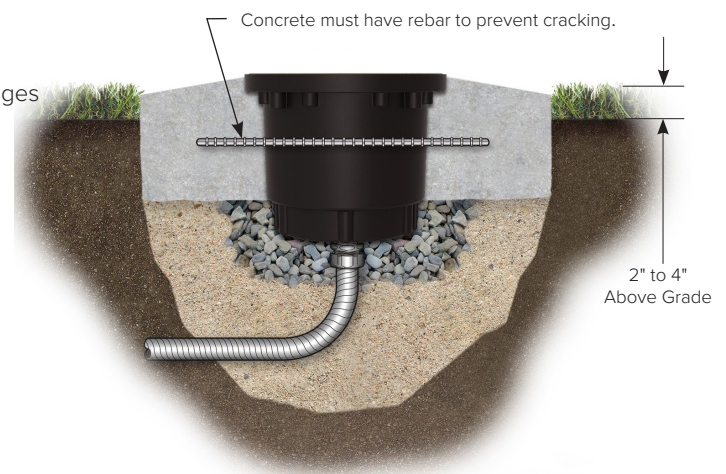

Note: Always use adequate rebar surrounding the fixture to prevent cracking of concrete.

USE REBAR CAGE ANCHOR IN PAVED AREAS

To make fixture installation easier in concrete, use Rebar Cage Anchor (RCA81/82/83) and tie into paving rebar to support fixture during concrete pour.

Advantages of paved area installation with rebar cage anchor

- Supports fixture during concrete pour.
- Can be easily tied into reinforcing rods used for paving
- Easily adapts to any paving material.

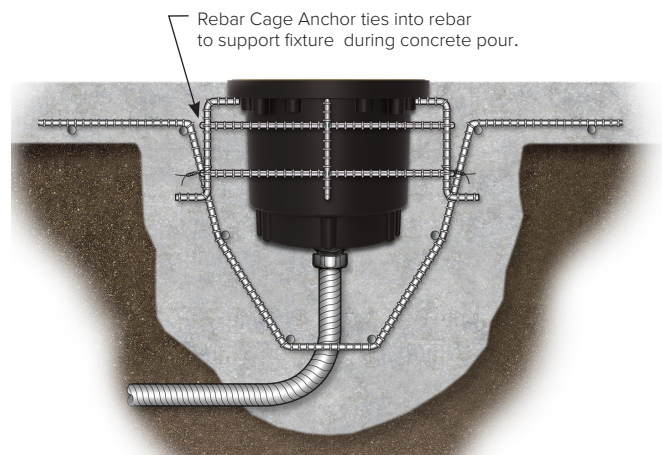

NOTE: Concrete foundation is to be designed according to local soil conditions (by others).

CAUTION:

- To help maintain a clean, dry splice compartment, **always apply sealant to both conduit threads and molded housing to seal.** (sealant not supplied.)
- When tightening gasketed splice cover into bottom of molded housing, always **Torque screws to 25-30 in-lbs in a star pattern.**
- Make sure all electrical supply is **OFF** before starting fixture installation.

ALIGNMENT: Fixture lens frames can be installed on housings at 90° Increments. Care must be taken when installing the housing so directional lens frames can be installed at a desired orientation.

Tools Required: RTV sealant, 3/16" tamper resistant hex wrench, adjustable wrench or pipe wrench

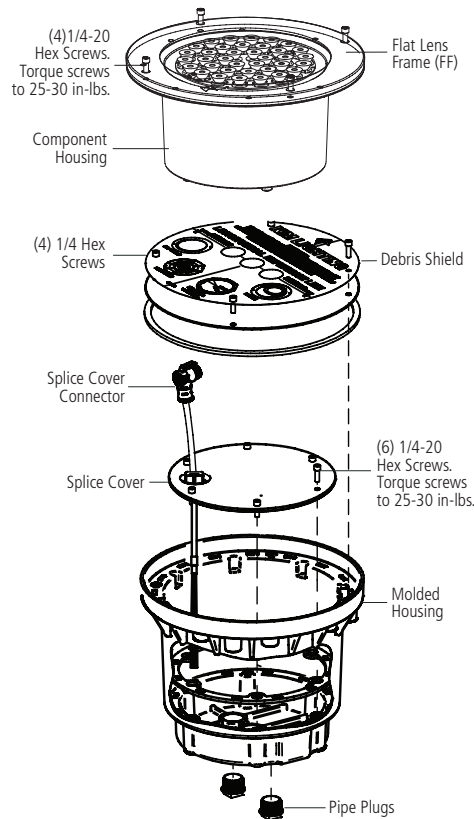

IMPORTANT SAFETY INSTRUCTIONS TO AVOID RISK OF FIRE OR INJURY!

WARNING: Fixtures must be grounded in accordance with local codes or the National Electrical Code. Failure to take these steps may result in serious personal injury. All electrical work should be done by a qualified electrician



SAFETY WARNING: DO NOT install these fixtures in submersible installations such as fountains or swimming pools. Extreme caution should be taken when installed in paved areas. **MAINTENANCE:** To maintain light efficiency and prevent overheating, lenses must be kept clean and free of dirt, dust, leaves, trash and mineral deposits from water. For optimum performance a regularly scheduled maintenance program should be followed. **DO NOT** operate luminaire with missing or damaged lens.

KEEP THIS SHEET FOR FUTURE REFERENCE.

FLUSH MOUNTING:

For flush mounting when installing in concrete, top edge of molded housing should be 3/16" below concrete grade.

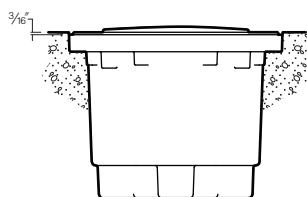

CAUTION

- Before installing de-energize circuit and lock out.

MOLDED HOUSING ROUGH-IN INSTALLATION:

Read guidelines on page 1 before starting.

1. Excavate 20" dia. hole in desired fixture location. Run conduit 3" deeper than height of housing. Fill with gravel for drainage.
2. With 3/16" Allen wrench, unscrew (4) hex screws to remove debris shield from molded housing.
3. **Check to make sure pour box is dry.**
4. Remove gasketed splice cover in bottom of molded housing using F" Allen wrench and (6) hex screws.
5. Remove pipe plugs from molded housing. Connect molded housing to conduit. **Apply sealant to both conduit threads and molded housing to seal.** (sealant not supplied.)
6. Pull (3) supply conductors into splice compartment.
7. **Standard Installation:** Connect (3) field wires to splice cover connector wires observing polarity, i.e. black (voltage), white (common), and green (ground). **Wire nut all three DMX leads together;** cutters or strippers will be required.
8. Cover the bottom of molded housing with a gasketed splice cover using 3/16" Allen wrench and (6) hex screws. **Torque screws to 25-30 in-lbs in a star pattern.**
9. With 3/16" Allen wrench, screw in (4) hex screws to reinstall debris shield.
10. Align molded housing using markings on debris shield keeping longitudinal reference line parallel to street, wall or walkway.
11. Back fill for stability. **Do not** back fill with bark or Vermiculite. **Never install below surrounding ground level.**

COMPONENT MODULE INSTALLATION:

12. When the component housing has been delivered to site and you're ready to install, unscrew (4) hex screws with 3/16" Allen wrench to remove debris shield.
13. Attach the connector to the housing by pressing it with your thumb/palm until it clicks into place. **Sealant on connectors is not necessary as rubber o-rings are in place to keep connectors water-tight.**
14. Drop component housing in place and attach to molded housing using 3/16" tamper resistant hex wrench and (4) tamper resistant hex screws. **Torque screws to 25-30 in-lbs.**
15. **NOTE:** When installing an LTV8 with Wall Wash distribution, the Kim Lighting logo on the rim of the housing should be placed closest to the wall.

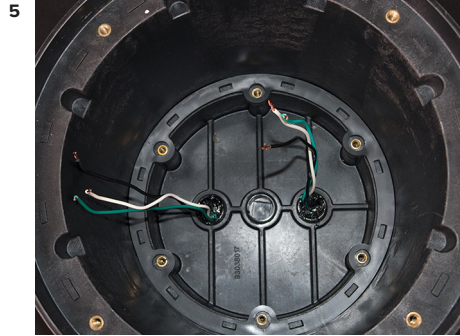

APPLE IOS (Current RGBW Connect App) - (Refer to device compatibility chart to insure that your device is compatible). LTV8 RGBW luminaire can be controlled wirelessly via Bluetooth® using the Current RGBW Connect App. The App requires an Apple device supporting Bluetooth® low energy (BLE).

To Set Up And Enable Wireless Controlled Optics:

1. For Apple iOS devices, go to the Apple App Store, search for Current Lighting, and download the Current RGBW Connect App.
2. Check your device "Settings" and make sure your Bluetooth® is turned on.
3. Plug-in/turn on power supply to your LTV8 RGBW luminaire(s).

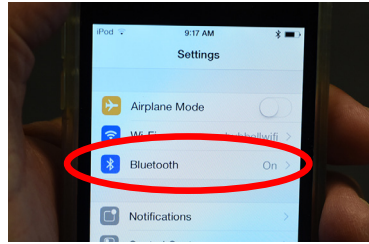

2. Turn on Bluetooth®.

4. Open Current RGBW Connect App
5. Tap on the Bluetooth® symbol in the bottom right hand corner of the screen on the navigation bar.
6. Under "Available Devices" select/tap on the device that you wish to pair up with. The luminaire in your closest proximity will be the highest on the list. Enter security code supplied in product documentation*.

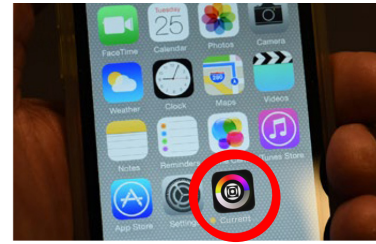

4. Open Current RGBW Connect App.

(Note: the maximum pairing range is 10 to 15 feet (3 m to 4.5 m) from luminaire.) If you get locked out of the App when you enter a wrong password - Exit the App, Clear the Cache and enter "KIMLTG". See Page 9 for instructions to clear Cache.

7. The fixture will pulse twice to confirm your connection.
8. To change the default security PIN, swipe to the left on the paired device and tap on the lock/key symbol. A box will pop up, allowing you to change/save a new password.

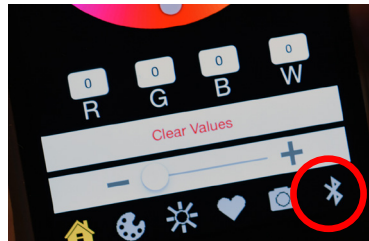

5. Click the connect icon.

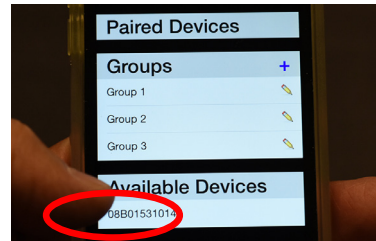

6. Select Device.

(Note: If you change the password, it is imperative that you write it down for easy recall and keep it in a secure place. Resetting the password will require the fixture to be sent back to the factory.)

Grouping Fixtures:

9. To create a group, first execute steps 6 and 7 above to pair up with as many "Available Devices" as you would like. Then, tap the (+) symbol to the right of where it says "Groups" on the screen. You will now see that there is a "Group 0" under the "Groups" section.
10. Next, swipe to the left over the first paired device that you would like to place into "Group 0". There is an icon that looks like a satellite. Tap on the satellite and a dialogue box will pop up asking which group you would like to place the paired device in (Group 0 will be your only option but as you create new "Groups" they will all be listed here). Tap on "Group 0" and that fixture is now in that group.

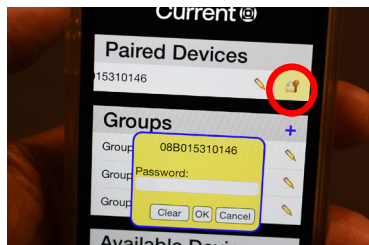

8. Change PIN and save.

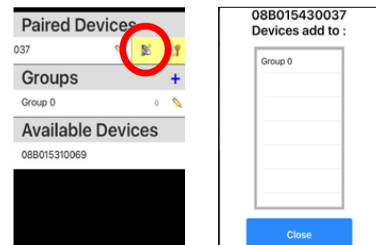

10. Swipe paired device left, tap satellite.

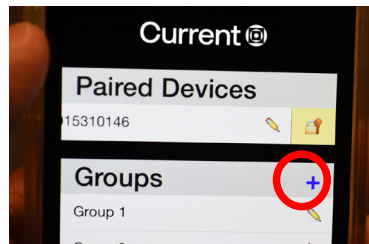

12. Tap pencil to rename group.

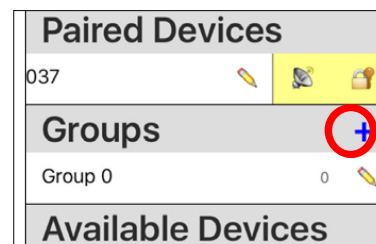

14. Tap blue "+" symbol pencil to add additional groups.

11. Repeat step 10 to place each device that you are paired up with into the group. Note, the total number of devices in a group are indicated next to the pencil symbol to the right of the group name. The first number indicated how many fixtures in the group you are paired with and the second number is the total number of fixtures in a group. For example, 10/12 would indicate that you have 12 fixtures in the group but you are only paired to/in range with 10 fixtures.
12. To rename a group, simply tap the "pencil" symbol to the right of the group you would like to rename, delete the default group name (i.e. Group 1, Group 2, etc.), and type in the new name.

13. To delete groups, swipe to the left over a group and tap the "X" in the green box.
14. To add additional groups, tap the blue "+" symbol to the right of the "Groups" header and a new blank/empty group will be added to the list. Once you tap on a Group to "pair up" with it, it will move from under the "Groups" heading to under the "Paired Devices" heading indicating that you are pairing up to all the fixtures within the group that are within range.

APPLE iOS (Cont. from previous page)

Three Ways to Select Color:

15. From “Color Wheel”

Tap on the “House/Home” symbol in the bottom left side of the screen on the navigation bar.

Rotate your finger around the color wheel until you find your desired color.

16. From “Color Palette”

Tap on the painters “color palette” symbol on the navigation bar at the bottom of your screen. You can either swipe your finger up and down the “color bar” on the left of the screen to choose your desired color, you can create your perfect color by individually moving the RGBW bars up and down until you reach the result you were looking for, or in each of the white boxes above each color slider, you can type in a specific RAL number/value if you know the specific color you are looking for.

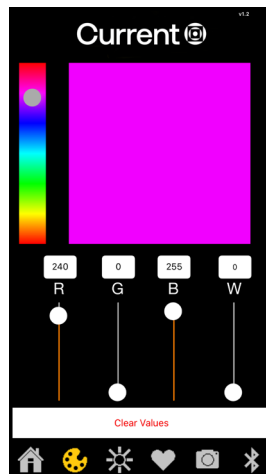

16. Select a color.

17. From “Camera”

Tap on the “Camera” symbol on the navigation bar running along bottom of the screen. Across the top, there are 2 buttons that you can select:

Album Button – Click on to enter your device’s photo album. Tap on/Select a photo that contains a color you would like to use. Once photo is opened, drag finger across your screen in order to move the “blue circle” over the color you would like to use from the photo. Tap “Set” and the luminaire will immediately change to that color.

Camera Button – Select, and your device’s camera will open up. Take a photo of something that contains a color that you would like the LTV8 luminaire to match. Drag finger across your device’s screen/photo to move the “blue circle” over the color you would like to use. Once you find the color, tap “Set” and the luminaire will immediately change to that color.

Save A Preset Color:

18. Adjust the luminaire to a color you would like to save for future use. Tap on the “Heart” symbol located on the middle-right of the navigation bar running along the bottom of your device’s screen.
19. To save your color, swipe to the left over one of the default presets and tap the “check mark” symbol.
20. Your color is now saved in preset slot. **Wait 10 seconds before unpairing to save your selected color.**



17. Select color from a camera or a photo.



18. Save preset.

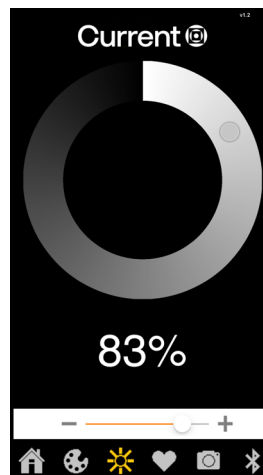

23/24. Adjust intensity.

21. To “Rename” a preset color, tap the “pencil” symbol adjacent to the color it represents, delete the default preset name (i.e. Preset 01, Preset 02, etc.), and name your new preset color whatever you would like. Adjust Intensity/Dim:

Adjust Intensity/Dim:

22. Tap on the “Star burst” symbol located on the middle-left of the navigation bar running along the bottom of your device’s screen.
23. Rotate your finger around the perimeter of the “Intensity Wheel” to achieve your desired dim/intensity setting.

Dimming:

24. Dimming/adjusting the intensity can also be achieved by sliding the bar between the plus and minus symbols back and forth.

ANDROID OS (Current RGBW BT Remote App) - (Refer to device compatibility chart to insure that your device is compatible). LTV8 RGBW luminaire can be controlled wirelessly via Bluetooth® using the Current RGBW BT Remote app. The App requires an Android device supporting Bluetooth® low energy (BLE).

To Set Up And Enable Wireless Controlled Optics:

1. For Android devices, go to Google Play and download the Current RGBW BT Remote app.
2. Check your device "Settings" and make sure your Bluetooth® is turned on.
3. Plug-in/turn on power supply to your LTV8 RGBW luminaire(s).
4. Open Current RGBW BT Remote app.
5. Tap on the Bluetooth® symbol in the bottom right hand corner of the screen on the navigation bar.
6. Under "Available Devices" select/tap on the device that you wish to pair up with. The luminaire in your closest proximity will be the highest on the list. Enter security code supplied in product documentation*.

(Note: the maximum pairing range is 10 to 15 feet (3 m to 4.5 m) from luminaire.) If you get locked out of the App when you enter a wrong password - Exit the App, Clear the Cache and enter "KIMLTG". See Page 9 for instructions to clear Cache.

7. The fixture will pulse twice to confirm your connection.
8. To change the default security PIN, swipe to the left on the paired device and tap on the lock/key symbol. A box will pop up, allowing you to change/save a new password.

(Note: If you change the password, it is imperative that you write it down for easy recall and keep it in a secure place. Resetting the password will require the fixture to be sent back to the factory.)

Grouping Fixtures:

9. To create a group, first execute steps 6 and 7 above to pair up with as many "Available Devices" as you would like. Then, tap the (+) symbol to the right of where it says "Groups" on the screen. You will now see that there is a "Group 0" under the "Groups" section.
10. Next, swipe to the left over the first paired device that you would like to place into "Group 0". There is an icon that looks like a satellite. Tap on the satellite and a dialogue box will pop up asking which group you would like to place the paired device in (Group 0 will be your only option but as you create new "Groups" they will all be listed here). Tap on "Group 0" and that fixture is now in that group.

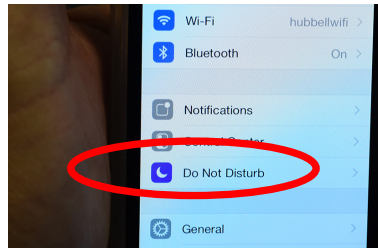

2. Turn on Bluetooth®.

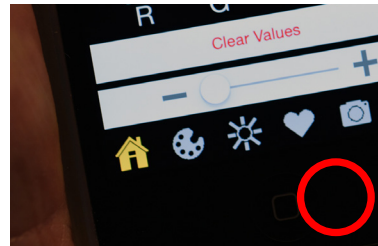

5. Click the connect icon.

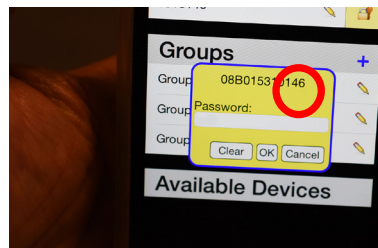

8. Change PIN and save.

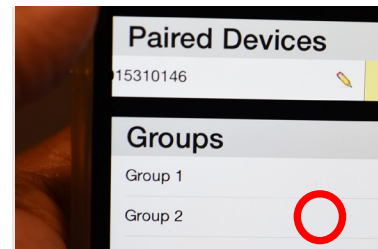

12. Tap pencil to rename group.

11. Repeat step 10 to place each device that you are paired up with into the group. Note, the total number of devices in a group are indicated next to the pencil symbol to the right of the group name. The first number indicated how many fixtures in the group you are paired with and the second number is the total number of fixtures in a group. For example, 10/12 would indicate that you have 12 fixtures in the group but you are only paired to/in range with 10 fixtures.
12. To rename a group, simply tap the "pencil" symbol to the right of the group you would like to rename, delete the default group name (i.e. Group 1, Group 2, etc.), and type in the new name.

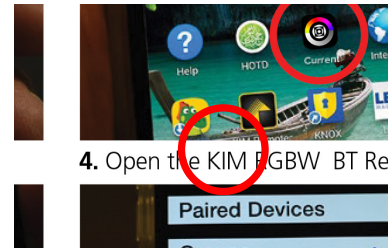

4. Open the KIM RGBW BT Re

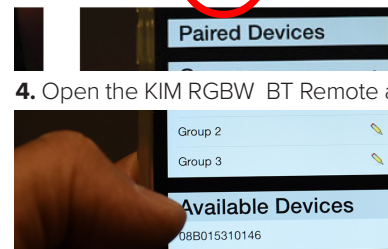

4. Open the KIM RGBW BT Remote app.

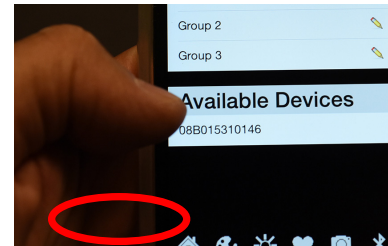

6. Select Device.

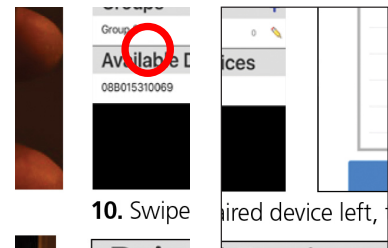

10. Swipe paired device left,

10. Swipe paired device left, tap satellite.

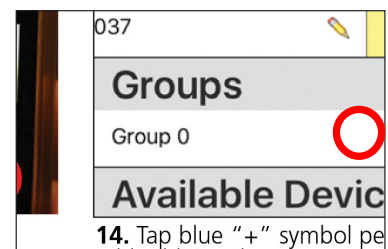

14. Tap blue "+" symbol pencil

14. Tap blue "+" symbol pencil to add additional groups.

13. To delete groups, swipe to the left over a group and tap the "X" in the green box.
14. To add additional groups, tap the blue "+" symbol to the right of the "Groups" header and a new blank/empty group will be added to the list. Once you tap on a Group to "pair up" with it, it will move from under the "Groups" heading to under the "Paired Devices" heading indicating that you are pairing up to all the fixtures within the group that are within range.

ANDROID OS (Cont. from previous page)

Three Ways to Select Color:

15. From “Color Wheel”

Tap on the “House/Home” symbol in the bottom left side of the screen on the navigation bar.

Rotate your finger around the color wheel until you find your desired color.

16. From “Color Palette”

Tap on the painter’s “color palette” symbol on the navigation bar at the bottom of your screen. You can either swipe your finger up and down the “color bar” on the left of the screen to choose your desired color, or you can create your perfect color by individually moving the RGBW bars up and down until you reach the result you were looking for.

17. From “Camera”

Tap on the “Camera” symbol on the navigation bar running along bottom of the screen. Across the top, there are 2 buttons that you can select:

Album Button – Click on to enter your device’s photo album. Tap on/Select a photo that contains a color you would like to use. Once photo is opened, drag finger across your screen in order to move the “blue circle” over the color you would like to use from the photo. Tap “Set” and the luminaire will immediately change to that color.

Camera Button – Select, and your device’s camera will open up. Take a photo of something that contains a color that you would like the LTV8 RGBW luminaire to match. Drag finger across your device’s screen/photo to move the “blue circle” over the color you would like to use. Once you find the color, tap “Set” and the luminaire will immediately change to that color.

Save A Preset Color:

18. Adjust the luminaire to a color you would like to save for future use. Tap on the “Heart” symbol located on the middle-right of the navigation bar running along the bottom of your device’s screen.
19. To save your color, swipe to the left over one of the default presets and tap the “check mark” symbol.
20. Your color is now saved in preset slot. **Wait 10 seconds before unpairing to save your selected color.**
21. To “Rename” a preset color, tap the “pencil” symbol adjacent to the color it represents, delete the default preset name (i.e. Preset 01, Preset 02, etc.), and name your new preset color whatever you would like.



16. Select a color.

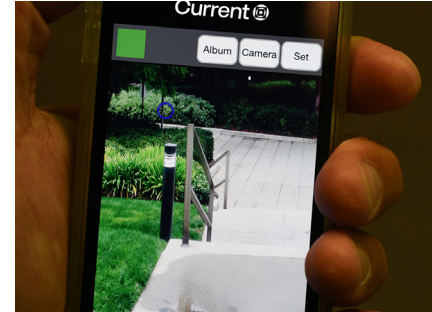

17. Select color from a camera or a photo.

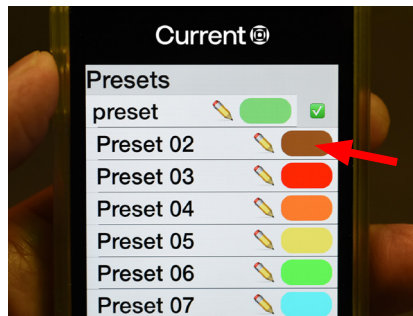

18. Save preset.

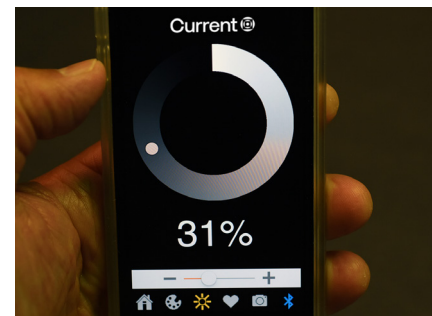

23/24. Adjust intensity.

Adjust Intensity/Dim:



22. Tap on the “Star burst” symbol located on the middle-left of the navigation bar running along the bottom of your device’s screen.
23. Rotate your finger around the perimeter of the “Intensity Wheel” to achieve your desired dim/intensity setting.

Dimming:

24. Dimming/adjusting the intensity can also be achieved by sliding the bar between the plus and minus symbols back and forth.

APPLE iOS Cache

Clearing the cache:

1. If you are locked out of the Current RGBW Remote App when you enter the wrong password Exit the App, Clear the Cache by following the steps below–
 2. For an iOS Device, Click on Settings > Bluetooth®.
 3. Click on of the  of Device. 
 4. Click on “Forget this Device”
 5. Go back to the Current RGBW App and pair the device
- Go back to the Current RGBW App and pair the device again.

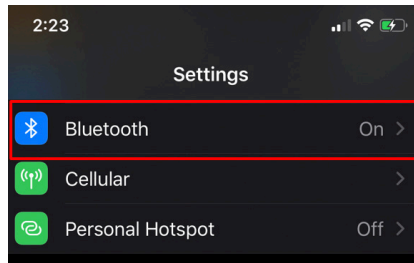

2. Turn on Bluetooth®.

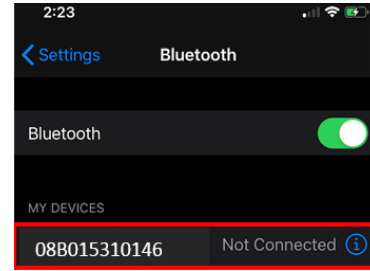

3. Information button

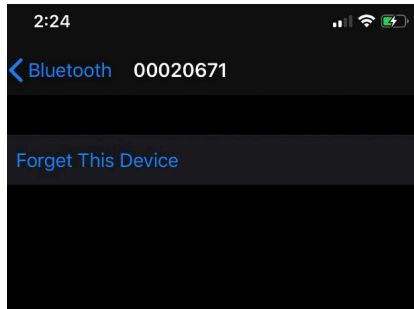

4. Forget Device.

Saving your selected color.

1. Wait 10 seconds before unpairing to save your selected color.

ANDROID OS Cache

Clearing the cache:

1. If you are locked out of the Current RGBW Remote App when you enter the wrong password Exit the App, Clear the Cache by following the steps below–
 2. For an Android Device, Click on Settings > Bluetooth®.
 3. Click unpair. 
 5. Go back to the Current RGBW App and pair the device again.
- Go back to the Current RGBW App and pair the device again.

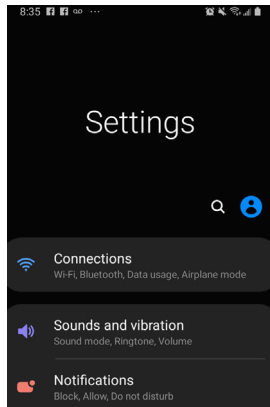

2. Turn on Bluetooth®.

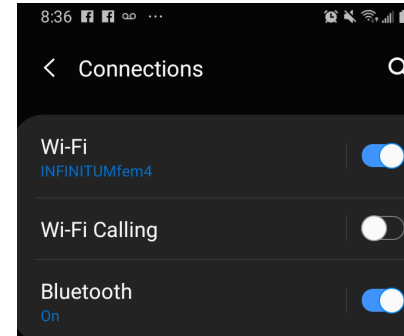

3. Information button

Saving your selected color.

1. Wait 10 seconds before unpairing to save your selected color.

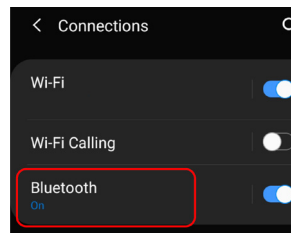

4. Forget Device.

Trouble pairing device and KIM REMOTE with fixture.

1. When pairing initially, stand as close as possible to the fixture.
2. Power down fixture for 15 seconds and power back on.
3. Pair one device at a time.
4. Close app. To do this on an Android device go to Settings > Applications (or Application Manager) > Downloaded > KIM REMOTE > Force Stop. To do this on an Apple device (iOS 7): Push home button twice, find KIM REMOTE app, hold the app icon and swipe up. To do this on an Apple device (iOS 6): Push home button twice, find KIM REMOTE app, tap the X to close.
5. We recommend using one type of bluetooth® device (apple or android) when pairing. When pairing multiple types of devices with the same fixture, power down the fixture for 15 seconds before switching devices.
6. A phone case/cover may interfere with the Bluetooth® signal. Removing your case can significantly improve connectivity.

Saving your selected color.

1. Wait 10 seconds before unpairing to save your selected color.

Why did my dimming settings change?

The advanced electronics inside the Kim Flood are designed to retain your settings for both dimming and aiming.

Note: Each time you **connect** to the fixture with the KIM REMOTE app, dimming settings are automatically reset to 100%. Please follow the following step.

1. Power on fixture.
2. Pair and **Connect** device.
3. Aim and set dimming.
4. **Disconnect** the device. (This will store your settings in memory)
5. Once settings are stored the fixture does not require power to retain settings.

NOTE Saving prior color and dim state:

The Kim LTV8 has a unique feature that “saves” the last state colored light output commanded of it. The command can come via Bluetooth® App, or DMX, so that the next time the unit is powered on, it will output that saved value. In order for this feature to work, after making your changes on either Bluetooth® or DMX, **do not make any changes to the state for at least 10 seconds before disconnecting the Bluetooth® app, removing the DMX signal, or powering down the Kim LTV8 unit.** This delay is necessary for the Kim LTV8 to detect that no changes are happening, and it is safe to log the last state to memory.

























The Bluetooth® word mark and logos are registered trademarks owned by Bluetooth® SIG, Inc. and any use of such marks by Kim Lighting is under license. Other trademarks and trade names are those of their respective owners.

Apple, the Apple logo, iPad, iPhone, and iPod Touch are trademarks of Apple Inc., Registered in the U.S. and other countries. App Store is a service mark of Apple Inc. Google Play is a trademark of Google Inc.

Installation warnings and cautions for standard product

Avertissements d'installation et mises en garde

-  **WARNING:** Make certain all electrical supply is OFF before starting installation or beginning maintenance procedures.
-  **AVERTISSEMENT:** S'assurer que toute alimentation possible est COUPEE avant de commencer l'installation ou l'entretien.
-  **WARNING:** Fixtures must be grounded in accordance with local codes or the National Electrical Code. Failure to do so may result in serious personal injury.
-  **AVERTISSEMENT:** Les appareils doivent être mis à la terre en conformité avec le Code canadien de l'électricité et les codes locaux. Une non-conformité pourrait conduire à des blessures graves.
-  **WARNING:** To prevent wiring damage or abrasion, do not expose wiring to edges of sheet metal or other sharp objects.
-  **AVERTISSEMENT:** Pour empêcher l'endommagement ou l'éraflure des fils, empêchez tout contact avec les rebords des parties métalliques.
-  **MAINTENANCE:** A regularly scheduled maintenance program should be established to retain optimum light output and reduce heat retention. Dusting with a soft, clean, dry cloth is normally sufficient for the reflector.
-  **ENTRETIEN:** Un programme d'entretien régulier devrait être établi pour conserver la luminosité optimale et réduire l'accumulation de chaleur. Un chiffon doux et propre est normalement suffisant pour dépoussiérer le réflecteur optique. Ne pas utiliser de produit nettoyant alcalin ou acide sur les surfaces du réflecteur.
-  **NOTE:** All wiring must be done by a qualified electrician.
-  **REMARQUE:** Tout le câblage doit être fait par un électricien certifié.
-  **CAUTION:** LED fixtures are available in 120 volt input or 277 volt input. Please verify before wiring fixture to field wires. (see lamp label to verify).
-  **MISE EN GARDE:** Les appareils d'éclairage à DEL sont offerts pour alimentation à 120 V ou 277 V. Veuillez vérifier avant de raccorder (voir l'étiquette de l'appareil pour confirmer).
-  **WARNING:** The H.I.D./Fluorescent fixtures utilizes a lamp that may contain mercury. For information on disposal of lamp go to website: www.lamprecycle.org.
-  **AVERTISSEMENT:** Les appareils d'éclairage à décharge à haute intensité ou à fluorescents peuvent contenir du mercure. Pour l'information de disposition des ampoules/tubes, visitez le site Web: www.lamprecycle.org.
-  **CAUTION:** Lighted lamp is HOT! Do not touch hot lens, guard or enclosure. DO NOT operate fixtures with missing or damage lens.
-  **MISE EN GARDE:** Les ampoules allumées sont CHAUDES! Ne pas toucher leur lentille de diffraction, garde protectrice ou le boîtier. NE PAS allumer d'appareil d'éclairage dont la lentille serait absente ou endommagée.
-  **WARNING:** Photocell, if used, must match input voltage to ballast.
-  **AVERTISSEMENT:** Toute cellule électrique utilisée doit être de la même tension que le ballast.
-  **CAUTION:** For H.I.D. fixtures, label must indicate the same electrical data as the ballast label. Use only the lamp type and wattage shown on the fixture label in the reflector.
- Attention:** If fixture is equipped with a multi-tap ballast and if not voltage was specified on the purchase order, the ballast has been wired for operation on a 277 volt circuit (347V for Canada). If other than 277 volts is required, i.e. 120v, 208v, 240v, connect incoming voltage lead to selected voltage lead on ballast.
-  **MISE EN GARDE:** Pour les appareils d'éclairage à décharge à haute intensité, la tension indiquée sur l'étiquette doit être la même que celle indiquée sur l'étiquette du ballast. N'utiliser que des ampoules de type et de puissance indiquées à l'étiquette du réflecteur de l'appareil. **Attention:** Si l'appareil est muni d'un ballast multiprises et que la tension n'a pas été définie sur le bon de commande, le ballast a été câblé pour une tension de 347 V (277 V aux États-Unis). Si l'alimentation est de tension différente que 347 V (120 V, 208 V ou 240 V), raccorder le câble d'alimentation au fil de la bonne prise sur le ballast.
-  **SAFETY WARNING FOR QUARTZ LAMPS:** Fixtures can become very HOT depending on the lamp wattage used. Glass lenses and metal areas above and around the lamp can become HOT enough to blister hands. When relamping fixtures avoid touching quartz lamp envelope with bare hands. If touching the lamp is necessary during installation, clean the envelope with alcohol and dry with clean, soft cloth before burning. Contamination of the envelope may reduce lamp performance.
-  **DIRECTIVE DE SÉCURITÉ POUR LES AMPOULES QUARTZ-HALOGÈNE:** Selon la puissance des ampoules utilisées, ces appareils d'éclairage peuvent devenir très CHAUDS. La lentille de verre et les zones métalliques au-dessus et autour de l'ampoule peuvent devenir suffisamment CHAUDES pour brûler la peau. Lors du remplacement d'ampoules ne pas manipuler celles-ci à mains nues. S'il y a contact des doigts sur l'enveloppe de verre de l'ampoule, nettoyez-la avec de l'alcool et essuyez avec un linge propre et doux avant de l'allumer. La contamination de l'enveloppe réduirait la performance de l'ampoule.

Installation warnings and cautions for standard products (Continued)

Avertissements d'installation et mise en garde..

 **CAUTION:** Do not alter, relocate, or remove wiring, lampholders, ballasts, or any other electrical components.

 **ATTENTION:** Ne pas modifier, déplacer ni enlever de câble, de douille de lampe, de ballast ou autre composant électrique.

 **ADDITIONAL WARNINGS**

 **AVERTISSEMENTS SUPPLÉMENTAIRES**

For in ground fixtures

 **SAFETY WARNING: DO NOT** install these fixtures in submersible installations such as fountains or swimming pools. Extreme caution should be taken when installed in paved areas.

Pour les appareils d'éclairage enterrés

 **DIRECTIVE DE SÉCURITÉ: NE PAS** installer ces appareils d'éclairage dans les endroits submergés comme les bassins de fontaines ou les piscines. Une extrême prudence doit être observée lors du montage sur des surfaces pavées.

 **CAUTION:** To help maintain a clean, dry splice compartment, seal the conduit entries with RTV.

 **MISE EN GARDE:** Pour garder le compartiment de jonction des fils propre et sec, scellez les entrées de conduits avec du composé RTV.

 **CAUTION:** Some fixtures are not approved for walk-over areas, reference instruction sheet supplied with fixture.

 **MISE EN GARDE:** Certains appareils d'éclairage ne sont pas approuvés pour montage dans les aires piétonnières. Se référer aux directives de la feuille fournie avec l'appareil.

For Landscape fixtures

 **WARNING:** Portable spear or tree mounts using a cord and plug must be plugged into a receptacle protected by a Ground Fault Circuit Interrupter (GFCI) in accordance with the National Electrical Code. Failure to do so may result in serious personal injury.

Pour appareils d'aménagement paysager

 **AVERTISSEMENT:** Selon le Code national de l'électricité, les appareils portatifs de type lance ou pour montage dans les arbres qui sont munis de cordon et fiche, doivent être branchés dans une prise à protection par disjoncteur de mise à la terre. Une non-conformité pourrait conduire à des blessures graves.

 **CAUTION:** Particular care should be taken not to locate fixtures where small children can reach them if higher wattages are used.

 **MISE EN GARDE:** Une attention particulière devrait être portée pour ne pas installer les appareils d'éclairage dans les endroits accessibles par les jeunes enfants, spécialement si la puissance de l'ampoule est élevée.

For 12v Landscape fixtures:

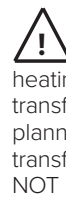
 **WARNING:** To reduce the risk of fire or injury, DO NOT overdrive fixtures with greater than 12 volts or fixture over-heating and short lamp life will occur. DO NOT overload the transformer by installing (or relamping) higher wattage lamps than planned. Note: Total wattage of all lamps connected to one transformer MUST NOT exceed the capacity of that transformer. DO NOT install fixtures within 10 feet (3.04m) of a pool, spa or fountain.

Pour appareils d'aménagement paysager à 12 V

 **AVERTISSEMENT:** Pour réduire le risque d'incendie ou de blessures, NE PAS alimenter ces appareils d'éclairage à plus de 12 V car ceci conduira à une surchauffe de l'appareil et raccourcira la vie de l'ampoule. NE PAS surcharger le transformateur en utilisant des ampoules de puissance plus élevée que prévu, lors de l'installation ou des remplacements. Remarque: La puissance totale des ampoules connectées à un transformateur NE DOIT PAS excéder la capacité de ce dernier. NE PAS installer ces appareils d'éclairage à moins de 3 m (10 pi) de piscines, spas ou fontaines.

**KEEP THIS SHEET FOR FUTURE REFERENCE.
CONSERVER LA PRÉSENTE FEUILLE POUR
RÉFÉRENCE ULTÉRIEURE.**

For warranty see currentlighting.com/kimlighting