

Pavilion 7" Round Concrete Bollard Installation Instructions



WARNING: Fixtures must be grounded in accordance with local codes or the National Electrical Code. Failure to do so may result in serious personal injury.

NOTE: All wiring must be done by a qualified electrician.

Luminaires provided with receptacle outlet panel, (42A-ROP / 42A-ROP-L), shall be provided with instructions to install weather resistant receptacles suitable for wet locations.

KEEP THIS SHEET FOR FUTURE REFERENCE.

Tools Required:

- #2 Phillips Screwdriver
- Ratchet Driver extension

- 3/4" Deep Socket, 6- or 12- point
- 1/8" Hex Key

- Ratchet Driver
- 9/16" Wrench



Make certain electrical supply is **OFF** before starting fixture installation.

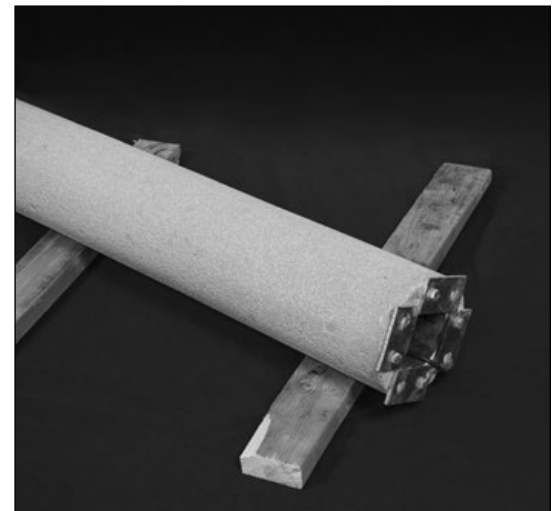

1. To protect finish, lay concrete bollard horizontally on wood blocks.

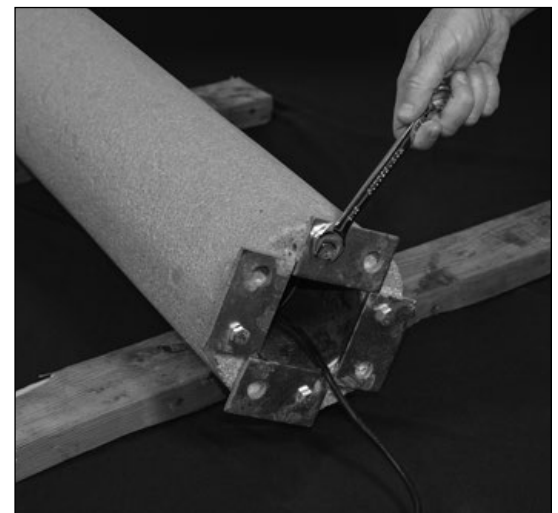

2. Install the four anchor plates using the four 3/8"-16 hex bolts provided. A 9/16" wrench is needed.

Pavilion 7" Round Concrete Bollard Installation Instructions

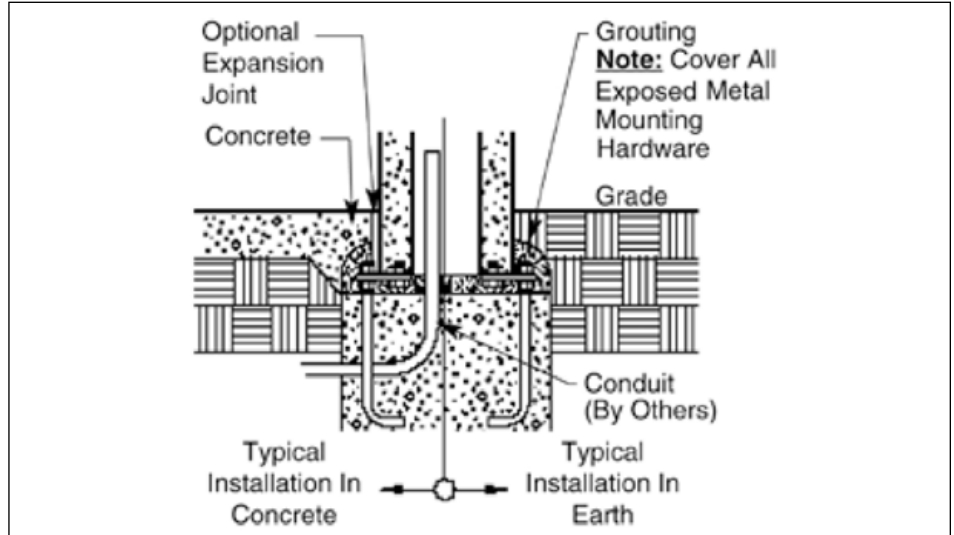
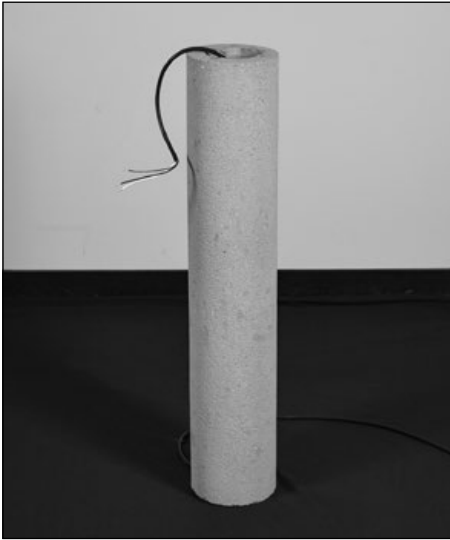

3. Route field wires through and out of the top of bollard. Concrete bollards are heavy; use adequate means to safely lift bollard and set it onto the ground-anchor bolts. Secure the bollard to the ground-anchor bolts, using the appropriate hardware and tools.

4. Make final adjustments to level the bollard by turning the bottom nuts on the 1/2"-13 ground-anchor bolts – the 3/4" drive socket will be needed for nut tightening. The bollard must have full contact with concrete foundation by grouting. Mounting hardware must not be in contact with soil or other corrosive elements. If the bollard top will not be installed until later, then cover the open top of the bollard body, so that water and debris will not collect inside.



5. Place the Luminous Element Lens on top of the pedestal. Note the up/down orientation of the Luminous Element Lens.



6. Attach the line voltage and grounding wires to the bottom terminal-wire block.

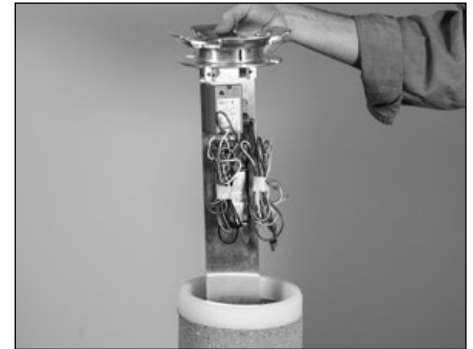

7. Lower the chassis assembly into the concrete pedestal. Be sure to route the chassis wires up through the top-center opening of the chassis.



8. Mechanically attach the chassis assembly to the concrete bollard using the four 1/4-20 Philips screws.



9. Connect the wires between the top of the chassis assembly and the bottom of the bollard head. Be sure to match wire colors (red-to-red, white-to-white, etc.).



10. Lower the head assembly, and tighten the four set screws using the 1/8" allen wrench:

Pavilion 7" Round Concrete Bollard Installation Instructions

MOUNTING

CONCRETE BODY

Once attached to base mounting plate, fixture may be rotated 20° in either direction and secured with set screws at base of the bollard body. KIM Lighting logo indicates 'street side' output

Round/Square Pavilion

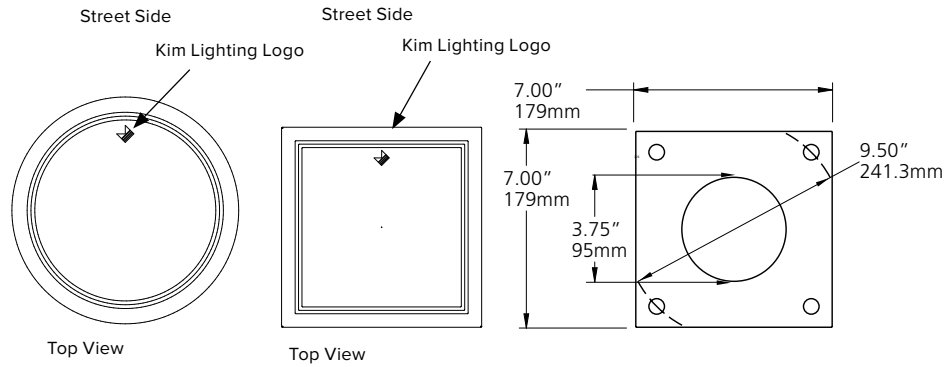

Shielding

HS configurations feature factory installed 180° shield(s) that may also be installed in the field for any Optic configuration

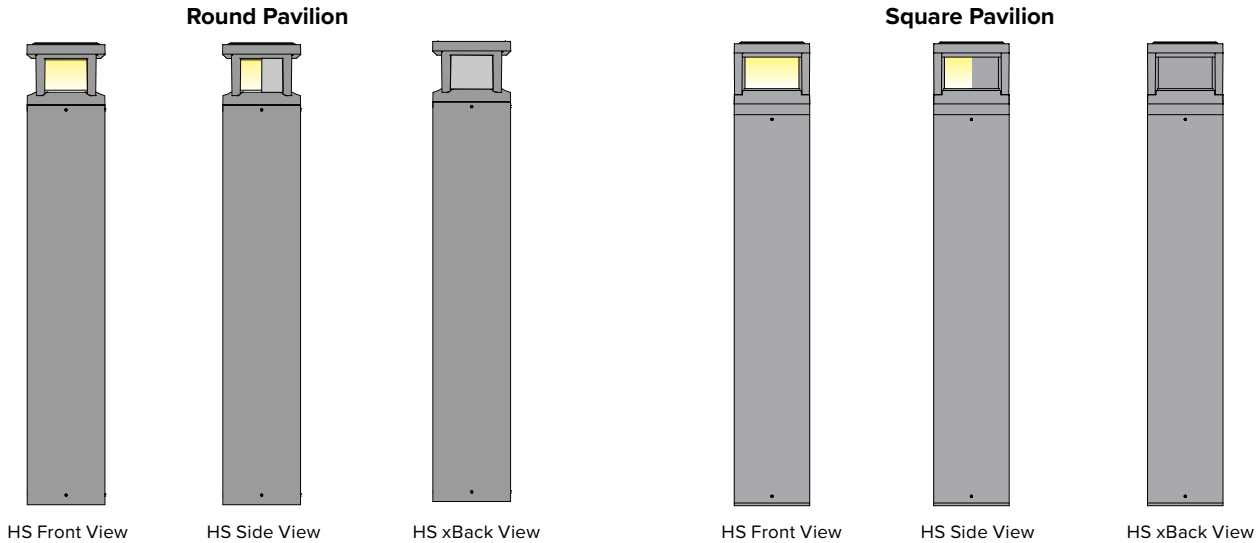

Pavilion 7” Round Concrete Bollard Installation Instructions

DMX fixtures can be hardwired with a single fixture layout or daisy chained for multiple fixture layout.

DMX WIRING MULTIPLE FIXTURES

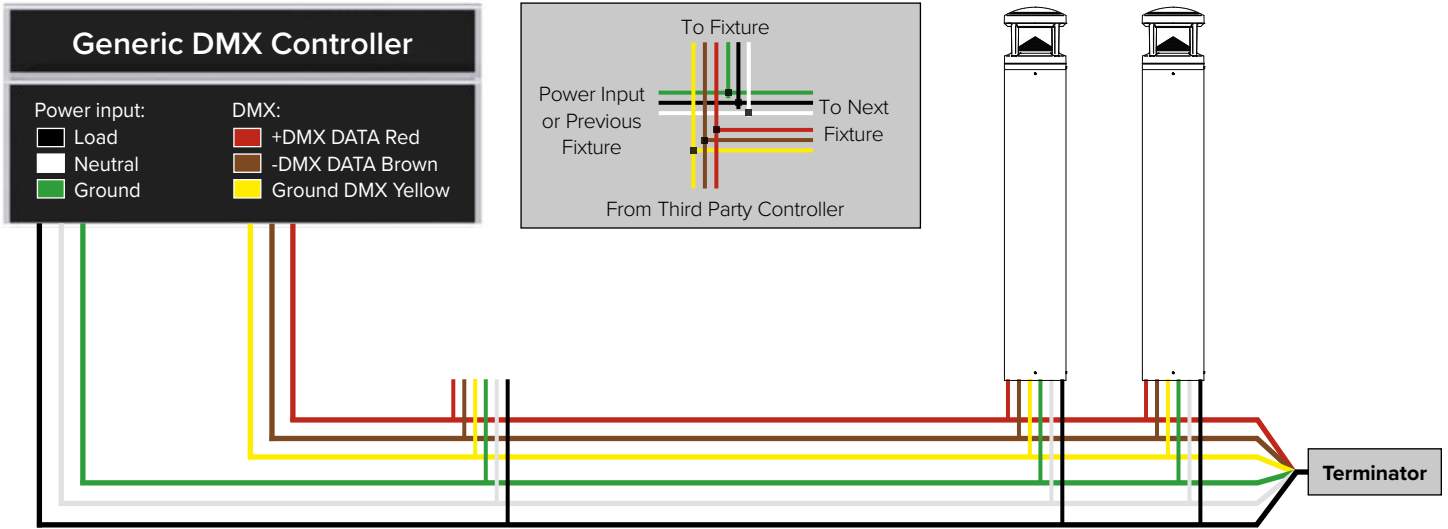

DMX WIRING SINGLE FIXTURE

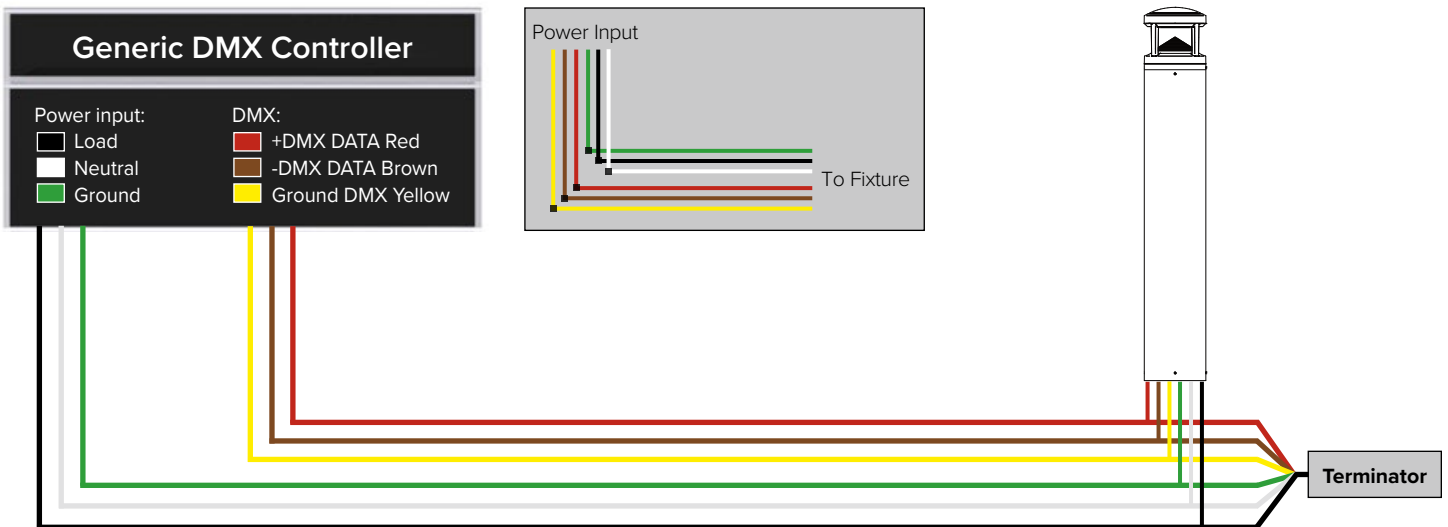

DMX ADDRESS

Address +1	Red Channel - Intensity = 0-255 Intensity → 0-100% brilliance
Address +2	Green Channel - Intensity = 0-255 Intensity → 0-100% brilliance
Address +3	Blue Channel - Intensity = 0-255 Intensity → 0-100% brilliance
Address +4	White Channel - Intensity = 0-255 Intensity → 0-100% brilliance

- DMX and Power cables must NOT be run in the same conduit.
- A DMX Terminator is required at the end of each run. A 121 ohm resistor can be connected across the DMX+ and DMX- wires to maintain data integrity.
- Fixture cabling from Control Box to fixture shall be installed per NEC and Local Codes.

For more information about DMX read the [Current DMX White Paper](#)

Pavilion 7” Round Concrete Bollard Installation Instructions

APPLE iOS (Current RGBW Connect App) - (Refer to device compatibility chart to insure that your device is compatible). Pavilion RGBW luminaire can be controlled wirelessly via Bluetooth® using the Current RGBW Connect App. The App requires an Apple device supporting Bluetooth® low energy (BLE).

To Set Up And Enable Wireless Controlled Optics:

1. For Apple iOS devices, go to the Apple App Store, search for Current, and download the Current RGBW Connect App.

2. Check your device “Settings” and make sure your Bluetooth® is turned on.

3. Plug-in/turn on power supply to your Pavilion RGBW luminaire(s).

4. Open Current RGBW Connect App

5. Tap on the Bluetooth® symbol in the bottom right hand corner of the screen on the navigation bar.

6. Under “Available Devices” select/tap on the device that you wish to pair up with. The luminaire in your closest proximity will be the highest on the list. Enter security code supplied in product documentation*.

(Note: the maximum pairing range is 10 to 15 feet (3 m to 4.5 m) from luminaire.) If you get locked out of the App when you enter a wrong password - Exit the App, Clear the Cache and enter “KIMLTG”. See Page 9 for instructions to clear Cache.

7. The fixture will pulse twice to confirm your connection.

8. To change the default security PIN, swipe to the left on the paired device and tap on the lock/key symbol. A box will pop up, allowing you to change/save a new password.

(Note: If you change the password, it is imperative that you write it down for easy recall and keep it in a secure place. Resetting the password will require the fixture to be sent back to the factory.)

Grouping Fixtures:

9. To create a group, first execute steps 6 and 7 above to pair up with as many “Available Devices” as you would like. Then, tap the (+) symbol to the right of where it says “Groups” on the screen. You will now see that there is a “Group 0” under the “Groups” section.

10. Next, swipe to the left over the first paired device that you would like to place into “Group 0”. There is an icon that looks like a satellite. Tap on the satellite and a dialogue box will pop up asking which group you would like to place the paired device in (Group 0 will be your only option but as you create new “Groups” they will all be listed here). Tap on “Group 0” and that fixture is now in that group.

11. Repeat step 10 to place each device that you are paired up with into the group. Note, the total number of devices in a group are indicated next to the pencil symbol to the right of the group name. The first number indicated how many fixtures in the group you are paired with and the second number is the total number of fixtures in a group. For example, 10/12 would indicate that you have 12 fixtures in the group but you are only paired to/in range with 10 fixtures.

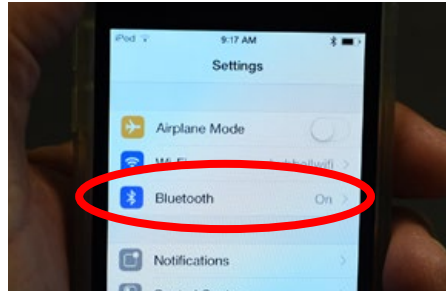

2. Turn on Bluetooth®.

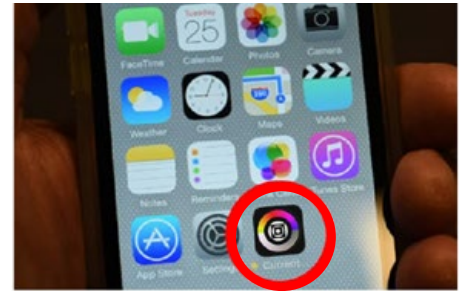

4. Open Current RGBW Connect App.

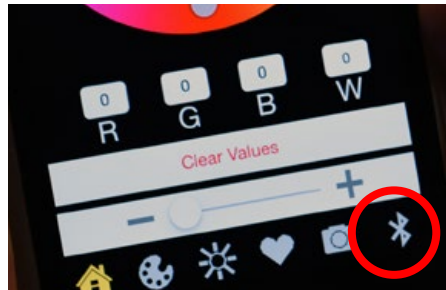

5. Click the connect icon.

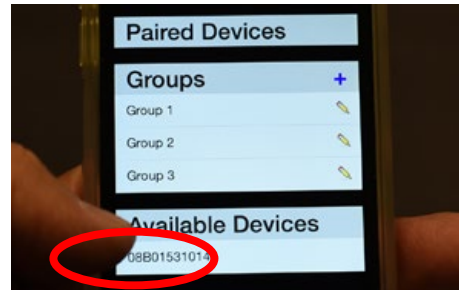

6. Select Device.

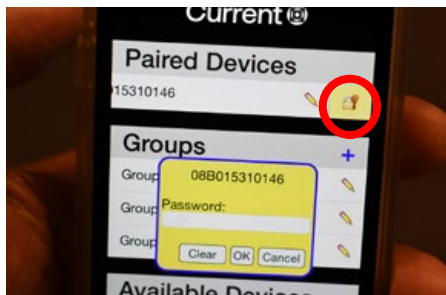

8. Change PIN and save.

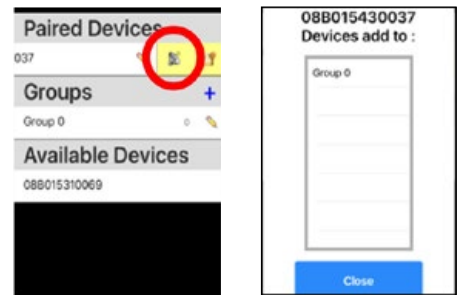

10. Swipe paired device left, tap satellite.

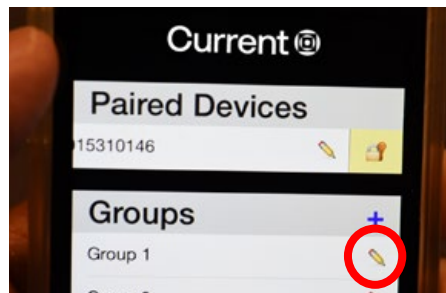

12. Tap pencil to rename group.

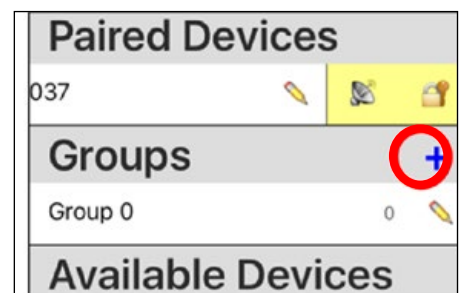

14. Tap blue “+” symbol pencil to add additional groups.

12. To rename a group, simply tap the “pencil” symbol to the right of the group you would like to rename, delete the default group name (i.e. Group 1, Group 2, etc.), and type in the new name.

13. To delete groups, swipe to the left over a group and tap the “X” in the green box.

14. To add additional groups, tap the blue “+” symbol to the right of the “Groups” header and a new blank/empty group will be added to the list. Once you tap on a Group to “pair up” with it, it will move from under the “Groups” heading to under the “Paired Devices” heading indicating that you are pairing up to all the fixtures within the group that are within range.

* For Bluetooth® pairing PIN see label near the serial number on the fixture or contact the factory or your agent.

APPLE iOS (Cont. from previous page)

Three Ways to Select Color:

15. From “Color Wheel”

Tap on the “House/Home” symbol in the bottom left side of the screen on the navigation bar.

Rotate your finger around the color wheel until you find your desired color.

16. From “Color Palette”

Tap on the painters “color palette” symbol on the navigation bar at the bottom of your screen. You can either swipe your finger up and down the “color bar” on the left of the screen to choose your desired color, you can create your perfect color by individually moving the RGBW bars up and down until you reach the result you were looking for, or in each of the white boxes above each color slider, you can type in a specific RAL number/value if you know the specific color you are looking for.

17. From “Camera”

Tap on the “Camera” symbol on the navigation bar running along bottom of the screen. Across the top, there are 2 buttons that you can select:

Album Button – Click on to enter your device’s photo album. Tap on/Select a photo that contains a color you would like to use. Once photo is opened, drag finger across your screen in order to move the “blue circle” over the color you would like to use from the photo. Tap “Set” and the luminaire will immediately change to that color.

Camera Button – Select, and your device’s camera will open up. Take a photo of something that contains a color that you would like the Pavilion RGBW luminaire to match. Drag finger across your device’s screen/photo to move the “blue circle” over the color you would like to use. Once you find the color, tap “Set” and the luminaire will immediately change to that color.

Save A Preset Color:

18. Adjust the luminaire to a color you would like to save for future use. Tap on the “Heart” symbol located on the middle-right of the navigation bar running along the bottom of your device’s screen.

19. To save your color, swipe to the left over one of the default presets and tap the “check mark” symbol.

20. Your color is now saved in preset slot. **Wait 10 seconds before unpairing to save your selected color.**

21. To “Rename” a preset color, tap the “pencil” symbol adjacent to the color it represents, delete the default preset name (i.e. Preset 01, Preset 02, etc.), and name your new preset color whatever you would like.

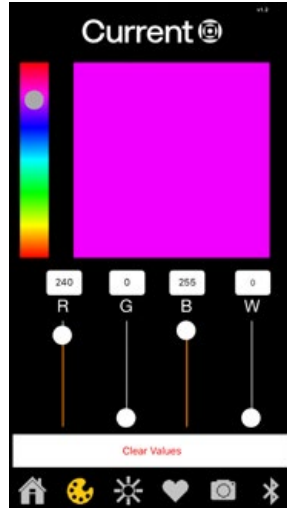

16. Select a color.

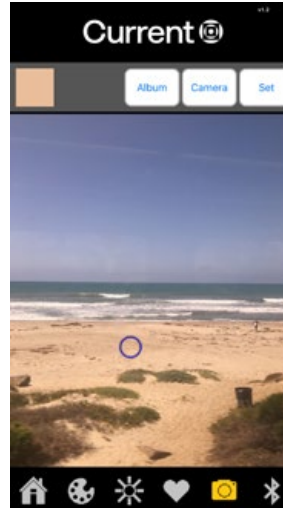

17. Select color from a camera or a photo.



18. Save preset.

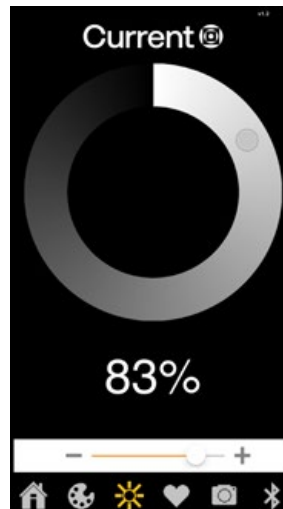

23/24. Adjust intensity.

Adjust Intensity/Dim:

22. Tap on the “Star burst” symbol located on the middle-left of the navigation bar running along the bottom of your device’s screen.

23. Rotate your finger around the perimeter of the “Intensity Wheel” to achieve your desired dim/intensity setting.

Dimming:

24. Dimming/adjusting the intensity can also be achieved by sliding the bar between the plus and minus symbols back and forth.

Pavilion 7” Round Concrete Bollard Installation Instructions

ANDROID OS (Current RGBW BT Remote App) - (Refer to device compatibility chart to insure that your device is compatible). Pavilion RGBW luminaire can be controlled wirelessly via Bluetooth® using the Current RGBW BT Remote app. The App requires an Android device supporting Bluetooth® low energy (BLE).

To Set Up And Enable Wireless Controlled Optics:

1. For Android devices, go to Google Play and download the Current RGBW BT Remote app.
2. Check your device “Settings” and make sure your Bluetooth® is turned on.
3. Plug-in/turn on power supply to your Pavilion RGBW luminaires(s).
4. Open Current RGBW BT Remote app.
5. Tap on the Bluetooth® symbol in the bottom right hand corner of the screen on the navigation bar.
6. Under “Available Devices” select/tap on the device that you wish to pair up with. The luminaire in your closest proximity will be the highest on the list. Enter security code supplied in product documentation*.
(Note: the maximum pairing range is 10 to 15 feet (3 m to 4.5 m) from luminaire.) If you get locked out of the App when you enter a wrong password - Exit the App, Clear the Cache and enter “KIMLTG”. See Page 9 for instructions to clear Cache.
7. The fixture will pulse twice to confirm your connection.
8. To change the default security PIN, swipe to the left on the paired device and tap on the lock/key symbol. A box will pop up, allowing you to change/save a new password.
(Note: If you change the password, it is imperative that you write it down for easy recall and keep it in a secure place. Resetting the password will require the fixture to be sent back to the factory.)

Grouping Fixtures:

9. To create a group, first execute steps 6 and 7 above to pair up with as many “Available Devices” as you would like. Then, tap the (+) symbol to the right of where it says “Groups” on the screen. You will now see that there is a “Group 0” under the “Groups” section.
10. Next, swipe to the left over the first paired device that you would like to place into “Group 0”. There is an icon that looks like a satellite. Tap on the satellite and a dialogue box will pop up asking which group you would like to place the paired device in (Group 0 will be your only option but as you create new “Groups” they will all be listed here). Tap on “Group 0” and that fixture is now in that group.
11. Repeat step 10 to place each device that you are paired up with into the group. Note, the total number of devices in a group are indicated next to the pencil symbol to the right of the group name. The first number indicated how many fixtures in the group you are paired with and the second number is the total number of fixtures in a group. For example, 10/12 would indicate that you have 12 fixtures in the group but you are only paired to/in range with 10 fixtures.

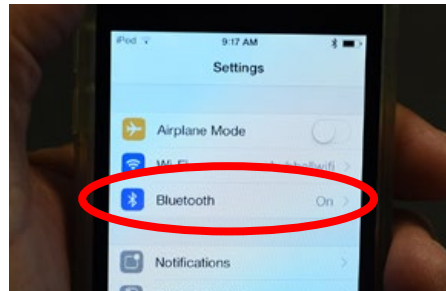

2. Turn on Bluetooth®.

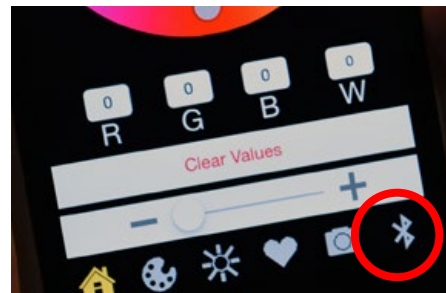

5. Click the connect icon.

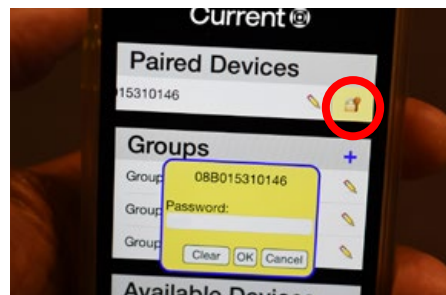

8. Change PIN and save.

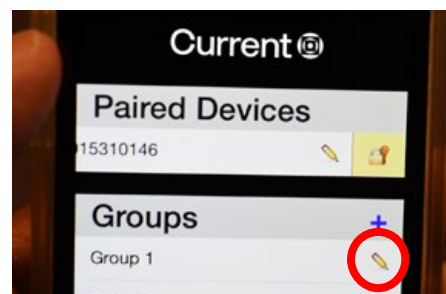

12. Tap pencil to rename group.

12. To rename a group, simply tap the “pencil” symbol to the right of the group you would like to rename, delete the default group name (i.e. Group 1, Group 2, etc.), and type in the new name.
13. To delete groups, swipe to the left over a group and tap the “X” in the green box.

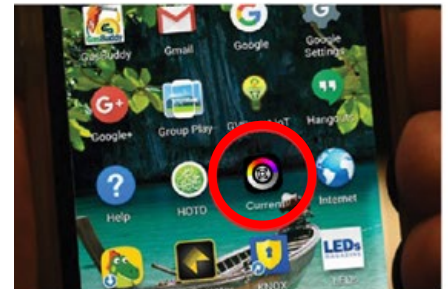

4. Open the KIM RGBW BT Remote app.

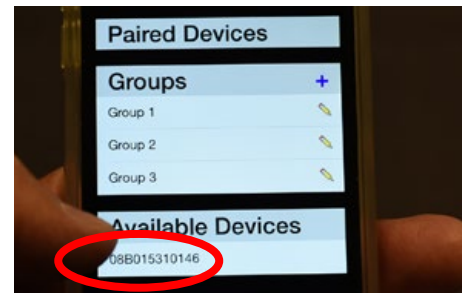

6. Select Device.

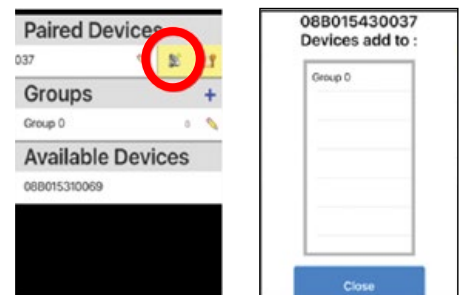

10. Swipe paired device left, tap satellite.

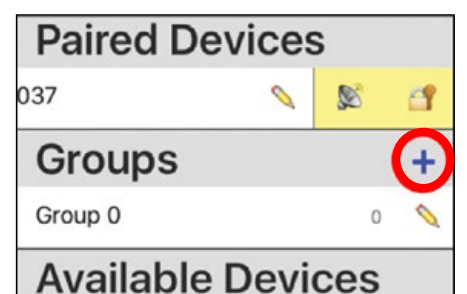

14. Tap blue “+” symbol pencil to add additional groups.

14. To add additional groups, tap the blue “+” symbol to the right of the “Groups” header and a new blank/empty group will be added to the list. Once you tap on a Group to “pair up” with it, it will move from under the “Groups” heading to under the “Paired Devices” heading indicating that you are pairing up to all the fixtures within the group that are within range.

* For Bluetooth® pairing PIN see label near the serial number on the fixture or contact the factory or your agent.

Three Ways to Select Color:

15. From “Color Wheel”

Tap on the “House/Home” symbol in the bottom left side of the screen on the navigation bar.

Rotate your finger around the color wheel until you find your desired color.

16. From “Color Palette”

Tap on the painter’s “color palette” symbol on the navigation bar at the bottom of your screen. You can either swipe your finger up and down the “color bar” on the left of the screen to choose your desired color, or you can create your perfect color by individually moving the RGBW bars up and down until you reach the result you were looking for.

17. From “Camera”

Tap on the “Camera” symbol on the navigation bar running along bottom of the screen. Across the top, there are 2 buttons that you can select:

Album Button – Click on to enter your device’s photo album. Tap on/Select a photo that contains a color you would like to use. Once photo is opened, drag finger across your screen in order to move the “blue circle” over the color you would like to use from the photo. Tap “Set” and the luminaire will immediately change to that color.

Camera Button – Select, and your device’s camera will open up. Take a photo of something that contains a color that you would like the Pavilion RGBW luminaire to match. Drag finger across your device’s screen/photo to move the “blue circle” over the color you would like to use. Once you find the color, tap “Set” and the luminaire will immediately change to that color.

Save A Preset Color:

18. Adjust the luminaire to a color you would like to save for future use. Tap on the “Heart” symbol located on the middle-right of the navigation bar running along the bottom of your device’s screen.
19. To save your color, swipe to the left over one of the default presets and tap the “check mark” symbol.
20. Your color is now saved in preset slot. **Wait 10 seconds before unpairing to save your selected color.**
21. To “Rename” a preset color, tap the “pencil” symbol adjacent to the color it represents, delete the default preset name (i.e. Preset 01, Preset 02, etc.), and name your new preset color whatever you would like.

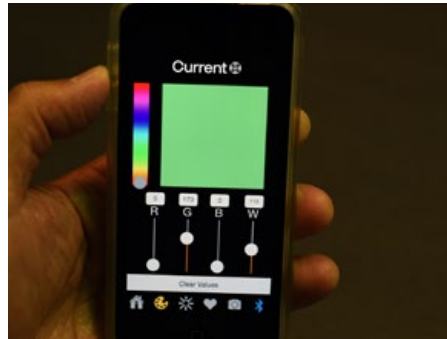

16. Select a color.

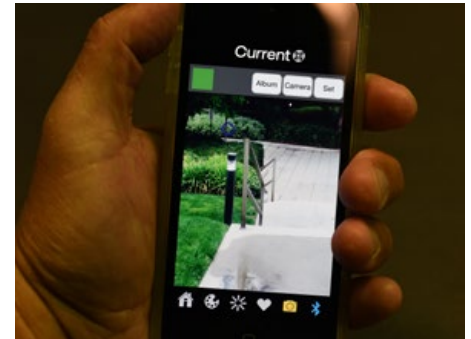

17. Select color from a camera or a photo.

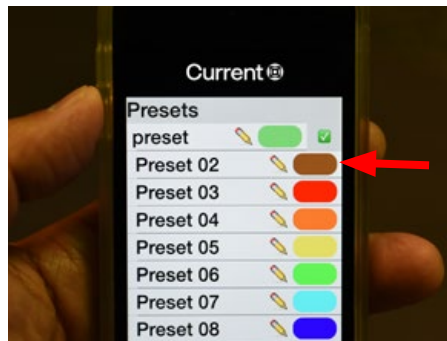

18. Save preset.

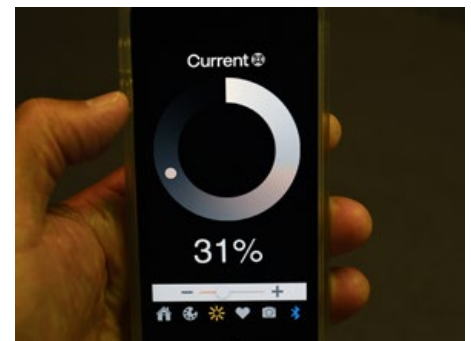

23/24. Adjust intensity.

Adjust Intensity/Dim:



22. Tap on the “Star burst” symbol located on the middle-left of the navigation bar running along the bottom of your device’s screen.
23. Rotate your finger around the perimeter of the “Intensity Wheel” to achieve your desired dim/intensity setting.

Dimming:

24. Dimming/adjusting the intensity can also be achieved by sliding the bar between the plus and minus symbols back and forth.

APPLE iOS Cache

Clearing the cache:

1. If you are locked out of the Current RGBW Remote App when you enter the wrong password Exit the App, Clear the Cache by following the steps below–
2. For an iOS Device, Click on Settings > Bluetooth®.
3. Click on of the  of Device.
4. Click on “Forget this Device”
5. Go back to the Current RGBW App  and pair the device again.

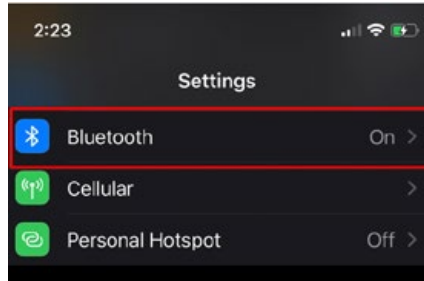

2. Turn on Bluetooth®.

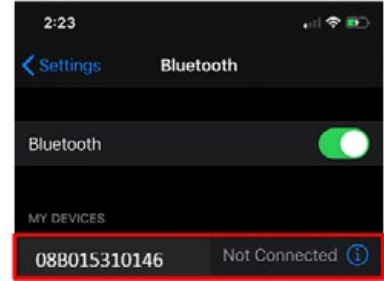

3. Information button

Saving your selected color.

1. Wait 10 seconds before unpairing to save your selected color.

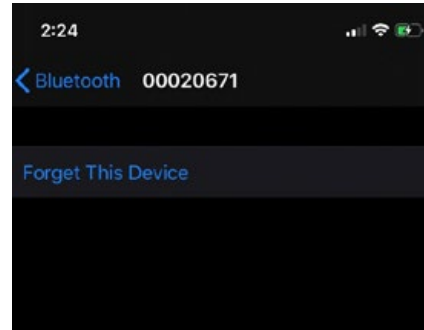

4. Forget Device.

ANDROID OS Cache

Clearing the cache:

1. If you are locked out of the Current RGBW Remote App when you enter the wrong password Exit the App, Clear the Cache by following the steps below–
 2. For an Android Device, Click on Settings > Bluetooth®.
 3. Click unpair.
 5. Go back to the Current RGBW App  and pair the device again.
- Go back to the Current RGBW App and pair the device again.

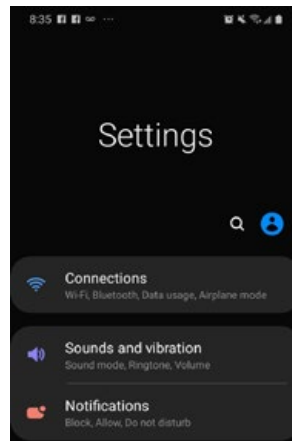

2. Turn on Bluetooth®.

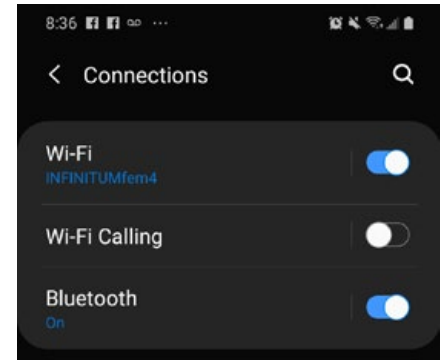

3. Information button

Saving your selected color.

1. Wait 10 seconds before unpairing to save your selected color.

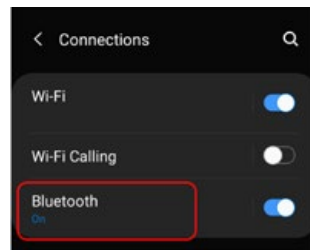

4. Forget Device.

Trouble pairing device and KIM REMOTE with fixture.

1. When pairing initially, stand as close as possible to the fixture.
2. Power down fixture for 15 seconds and power back on.
3. Pair one device at a time.
4. Close app. To do this on an Android device go to Settings > Applications (or Applications Manager) > Downloaded > KIM REMOTE > Force Stop. To do this on an Apple device (iOS 7): Push home button twice, find KIM REMOTE app, hold the app icon and swipe up. To do this on an Apple device (iOS 6): Push home button twice, find KIM REMOTE app, tap the X to close.
5. We recommend using one type of Bluetooth® device (apple or android) when pairing. When pairing multiple types of devices with the same fixture, power down the fixture for 15 seconds before switching devices.
6. A phone case/cover may interfere with the Bluetooth® signal. Removing your case can significantly improve connectivity.

Why did my dimming settings change?

The advanced electronics inside the Pavilion Bollard is designed to retain your settings for both dimming and aiming.

Note: Each time you **connect** to the fixture with the KIM REMOTE app, dimming settings are automatically reset to 100%. Please follow the following steps.

1. Power on fixture.
2. Pair and **Connect** device.
3. Aim and set dimming.
4. **Disconnect** the device. (This will store your settings in memory)
5. Once settings are stored the fixture does not require power to retain settings.























NOTE Saving prior color and dim state:

The Pavilion Bollard has a unique feature that "saves" the last state colored light output commanded of it. The command can come via Bluetooth® App, or DMX, so that the next time the unit is powered on, it will output that saved value. In order for this feature to work, after making your changes on either Bluetooth® or DMX, **do not make any changes to the state for at least 5 seconds before disconnecting the Bluetooth® app, removing the DMX signal, or powering down the Pavilion Bollard unit.** This delay is necessary for the Pavilion Bollard to detect that no changes are happening, and it is safe to log the last state to memory.





The Bluetooth® word mark and logos are registered trademarks owned by Bluetooth® SIG, Inc. and any use of such marks by Kim Lighting is under license. Other trademarks and trade names are those of their respective owners. Apple, the Apple logo, iPad, iPhone, and iPod Touch are trademarks of Apple Inc., registered in the U.S. and other countries. App Store is a service mark of Apple Inc. Google Play is a trademark of Google Inc.

Installation warnings and cautions for standard product**Avertissements d’installation et mises en garde**

-  **WARNING:** Make certain all electrical supply is OFF before starting installation or beginning maintenance procedures.
-  **AVERTISSEMENT:** S’assurer que toute alimentation possible est COUPEE avant de commencer l’installation ou l’entretien.
-  **WARNING:** Fixtures must be grounded in accordance with local codes or the National Electrical Code. Failure to do so may result in serious personal injury.
-  **AVERTISSEMENT:** Les appareils doivent être mis à la terre en conformité avec le Code canadien de l’électricité et les codes locaux. Une non-conformité pourrait conduire à des blessures graves.
-  **WARNING:** To prevent wiring damage or abrasion, do not expose wiring to edges of sheet metal or other sharp objects.
-  **AVERTISSEMENT:** Pour empêcher l’endommagement ou l’éraflure des fils, empêchez tout contact avec les rebords des parties métalliques.
-  **MAINTENANCE:** A regularly scheduled maintenance program should be established to retain optimum light output and reduce heat retention. Dusting with a soft, clean, dry cloth is normally sufficient for the reflector.
-  **ENTRETIEN:** Un programme d’entretien régulier devrait être établi pour conserver la luminosité optimale et réduire l’accumulation de chaleur. Un chiffon doux et propre est normalement suffisant pour dépoussiérer le réflecteur optique. Ne pas utiliser de produit nettoyant alcalin ou acide sur les surfaces du réflecteur.
-  **NOTE:** All wiring must be done by a qualified electrician.
-  **REMARQUE:** Tout le câblage doit être fait par un électricien certifié.
-  **CAUTION:** LED fixtures are available in 120 volt input or 277 volt input. Please verify before wiring fixture to field wires. (see lamp label to verify).
-  **MISE EN GARDE:** Les appareils d’éclairage à DEL sont offerts pour alimentation à 120 V ou 277 V. Veuillez vérifier avant de raccorder (voir l’étiquette de l’appareil pour confirmer).
-  **WARNING:** The H.I.D./Fluorescent fixtures utilizes a lamp that may contain mercury. For information on disposal of lamp go to website: www.lamprecycle.org.
-  **AVERTISSEMENT:** Les appareils d’éclairage à décharge à haute intensité ou à fluorescents peuvent contenir du mercure. Pour l’information de disposition des ampoules/tubes, visitez le site Web: www.lamprecycle.org.
-  **CAUTION:** Lighted lamp is HOT! Do not touch hot lens, guard or enclosure. DO NOT operate fixtures with missing or damage lens.
-  **MISE EN GARDE:** Les ampoules allumées sont CHAUDES! Ne pas toucher leur lentille de diffraction, garde protectrice ou le boîtier. NE PAS allumer d’appareil d’éclairage dont la lentille serait absente ou endommagée.
-  **WARNING:** Photocell, if used, must match input voltage to ballast.
-  **AVERTISSEMENT:** Toute cellule électrique utilisée doit être de la même tension que le ballast.
-  **CAUTION:** For H.I.D. fixtures, label must indicate the same electrical data as the ballast label. Use only the lamp type and wattage shown on the fixture label in the reflector. **Attention:** If fixture is equipped with a multi-tap ballast and if not voltage was specified on the purchase order, the ballast has been wired for operation on a 277 volt circuit (347V for Canada). If other than 277 volts is required, i.e. 120v, 208v, 240v, connect incoming voltage lead to selected voltage lead on ballast.
-  **MISE EN GARDE:** Pour les appareils d’éclairage à décharge à haute intensité, la tension indiquée sur l’étiquette doit être la même que celle indiquée sur l’étiquette du ballast. N’utiliser que des ampoules de type et de puissance indiquées à l’étiquette du réflecteur de l’appareil. **Attention:** Si l’appareil est muni d’un ballast multiprises et que la tension n’a pas été définie sur le bon de commande, le ballast a été câblé pour une tension de 347 V (277 V aux États-Unis). Si l’alimentation est de tension différente que 347 V (120 V, 208 V ou 240 V), raccorder le câble d’alimentation au fil de la bonne prise sur le ballast.
-  **SAFETY WARNING FOR QUARTZ LAMPS:** Fixtures can become very HOT depending on the lamp wattage used. Glass lenses and metal areas above and around the lamp can become HOT enough to blister hands. When relamping fixtures avoid touching quartz lamp envelope with bare hands. If touching the lamp is necessary during installation, clean the envelope with alcohol and dry with clean, soft cloth before burning. Contamination of the envelope may reduce lamp performance.
-  **DIRECTIVE DE SÉCURITÉ POUR LES AMPOULES QUARTZ-HALOGÈNE:** Selon la puissance des ampoules utilisées, ces appareils d’éclairage peuvent devenir très CHAUDS. La lentille de verre et les zones métalliques au-dessus et autour de l’ampoule peuvent devenir suffisamment CHAUDES pour brûler la peau. Lors du remplacement d’ampoules ne pas manipuler celles-ci à mains nues. S’il y a contact des doigts sur l’enveloppe de verre de l’ampoule, nettoyez-la avec de l’alcool et essuyez avec un linge propre et doux avant de l’allumer. La contamination de l’enveloppe réduirait la performance de l’ampoule.

Installation warnings and cautions for standard products (Continued)
Avertissements d'installation et mise en garde..

 **CAUTION:** Do not alter, relocate, or remove wiring, lampholders, ballasts, or any other electrical components.

 **ATTENTION:** Ne pas modifier, déplacer ni enlever de câble, de douille de lampe, de ballast ou autre composant électrique.

 **ADDITIONAL WARNINGS**

 **AVERTISSEMENTS SUPPLÉMENTAIRES**

For in ground fixtures

 **SAFETY WARNING: DO NOT** install these fixtures in submersible installations such as fountains or swimming pools. Extreme caution should be taken when installed in paved areas.

Pour les appareils d'éclairage enterrés

 **DIRECTIVE DE SÉCURITÉ: NE PAS** installer ces appareils d'éclairage dans les endroits submergés comme les bassins de fontaines ou les piscines. Une extrême prudence doit être observée lors du montage sur des surfaces pavées.

 **CAUTION:** To help maintain a clean, dry splice compartment, seal the conduit entries with RTV.

 **MISE EN GARDE:** Pour garder le compartiment de jonction des fils propre et sec, scellez les entrées de conduits avec du composé RTV.

 **CAUTION:** Some fixtures are not approved for walk-over areas, reference instruction sheet supplied with fixture.

 **MISE EN GARDE:** Certains appareils d'éclairage ne sont pas approuvés pour montage dans les aires piétonnières. Se référer aux directives de la feuille fournie avec l'appareil.

For Landscape fixtures

 **WARNING:** Portable spear or tree mounts using a cord and plug must be plugged into a receptacle protected by a Ground Fault Circuit Interrupter (GFCI) in accordance with the National Electrical Code. Failure to do so may result in serious personal injury.

Pour appareils d'aménagement paysager

 **AVERTISSEMENT:** Selon le Code national de l'électricité, les appareils portatifs de type lance ou pour montage dans les arbres qui sont munis de cordon et fiche, doivent être branchés dans une prise à protection par disjoncteur de mise à la terre. Une non-conformité pourrait conduire à des blessures graves.

 **CAUTION:** Particular care should be taken not to locate fixtures where small children can reach them if higher wattages are used.

 **MISE EN GARDE:** Une attention particulière devrait être portée pour ne pas installer les appareils d'éclairage dans les endroits accessibles par les jeunes enfants, spécialement si la puissance de l'ampoule est élevée.

For 12v Landscape fixtures:

 **WARNING:** To reduce the risk of fire or injury, DO NOT overdrive fixtures with greater than 12 volts or fixture over-heating and short lamp life will occur. DO NOT overload the transformer by installing (or relamping) higher wattages lamps than planned. Note: Total wattage of all lamps connected to one transformer MUST NOT exceed the capacity of that transformer. DO NOT install fixtures within 10 feet (3.04m) of a pool, spa or fountain.

Pour appareils d'aménagement paysager à 12 V

 **AVERTISSEMENT:** Pour réduire le risque d'incendie ou de blessures, NE PAS alimenter ces appareils d'éclairage à plus de 12 V car ceci conduira à une surchauffe de l'appareil et raccourcira la vie de l'ampoule. NE PAS surcharger le transformateur en utilisant des ampoules de puissance plus élevée que prévu, lors de l'installation ou des remplacements. Remarque: La puissance totale des ampoules connectées à un transformateur NE DOIT PAS excéder la capacité de ce dernier. NE PAS installer ces appareils d'éclairage à moins de 3 m (10 pi) de piscines, spas ou fontaines.

**KEEP THIS SHEET FOR FUTURE REFERENCE.
CONSERVER LA PRÉSENTE FEUILLE POUR
RÉFÉRENCE ULTÉRIEURE.**

For warranty see currentlighting.com/kimlighting