



HIGH SCHOOL

Illuminate your canopy savings

GALASY II

The **Galasy II**, now available in CCT and Lumen Switchable, is a budget friendly, canopy and soffit lighting solution. It is perfect solution for outdoor walkways, parking structures, security entryways, exterior canopies, loading docks and more. The Galasy II is a sleek, low profile, low glare solution for outstanding illumination.



The Galasy II is a stocked product, readily available to fill your immediate lighting needs. Contact Current today!

This fixture is designed for easy installation and maintenance, featuring a field servicable driver as well as the ability to service it under the canopy. It can be surface or pendant mounted with a 3/4" conduit. Accessories are available for HID replacements including retrofit cover plates, decorative beauty plates and a stem and junction box for pendant hanging.

FEATURES AND BENEFITS

- GSY-30 and GSY-65 are available in 120-277 Voltage
- GSY-150-LSCS is lumen switchable from 100 to 150 Watts and CCT Switchable in 4K7 and 5K7
- 30 and 65 Watt are Universal Voltage (120-277) and Switchable version available in 120-347 Voltage
- CCT Switchable 4000 and 5000K
- PIR motion sensor available as accessory for Switchable version
- High efficiency of up to 157 LPW for maximum energy savings
- DLC Premium Listed for maximum rebates



PERFORMANCE DATA

Description	Nominal Wattage	SYSTEM WATTS	DISTRIBUTION TYPE	5K (5000K nominal, 70CRI)					4K (4000K nominal, 70CRI)				
				LUMENS	LPW	B	U	G	LUMENS	LPW	B	U	G
GSY-30	30.29	30	V	4731	156	2	1	1	4750	157	2	1	1
GSY-65	65.4	65	V	9276	149	3	2	1	9315	154	3	2	1
GSY-150	100.5	100	V	15543	155	3	2	1	15699	157	3	2	1
	127.9	130	V	20205	155	4	2	2	20409	157	4	2	2
	152	150	V	22536	152	4	2	2	22762	157	4	2	2

FEATURES

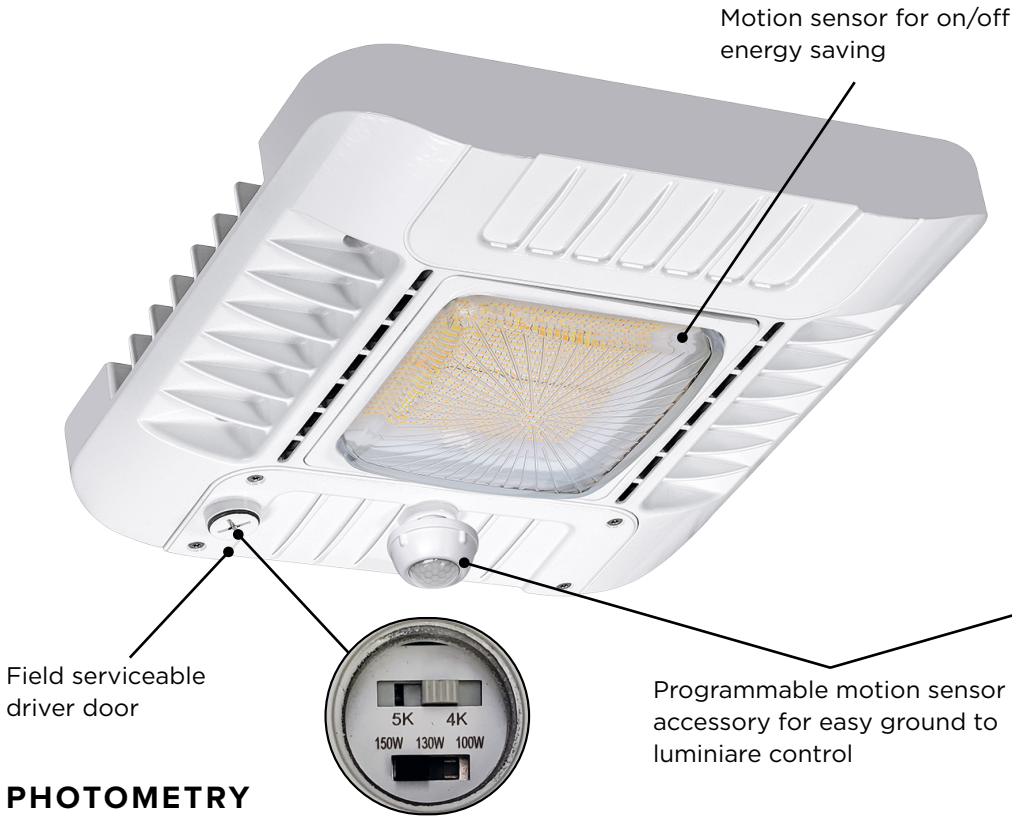

HB03DPR-Remote*
Programming Remote
for HB03DPR Sensor
* Only available for the
GSY-150-LSCS version



HB03DPR
Field Installed Occupancy
and Daylight Sensor

PHOTOMETRY

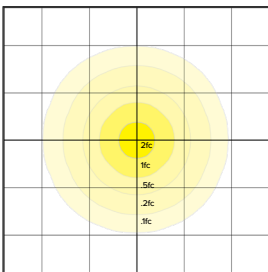

GSY-30-4K7
Scale: 1 = 20 ft.
Mounting Height: 25 ft.

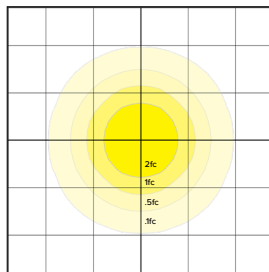

GSY-65-4K7
Scale: 1 = 20 ft.
Mounting Height: 25 ft.

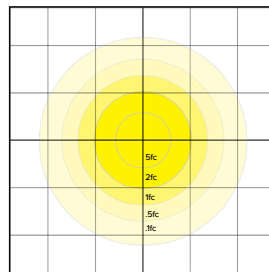

GSY-100-4K7
Scale: 1 = 20 ft.
Mounting Height: 25 ft.

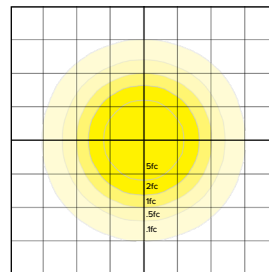

GSY-130-4K7
Scale: 1 = 20 ft.
Mounting Height: 15 ft.

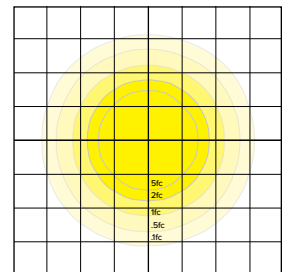

GSY-150-4K7
Scale: 1 = 20 ft.
Mounting Height: 15 ft.

DIMENSIONS

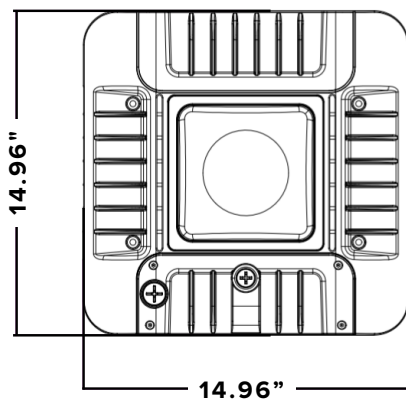

	Weight
Product	10 lbs. (4.53 kg)
Carton	12 lbs. (5.44 kg)

