



FEATURES

- Enclosed high efficiency lens features linear prism acrylic and provides visual comfort and high performance without pixelation
- Appropriate for schools, medical facilities, dining areas, locker rooms, and public spaces
- Enclosed lens protects against intrusion of contaminants
- High performance matte white paint standard.
- Optional Antimicrobial® paint (AM option) resists bacterial growth on exposed painted surfaces
- Lens gasket option and wet location listing available
- 60,000 hour LEDs at L80 for reduced life cycle maintenance costs
- Four LED color choices with excellent color consistency and 82 CRI
- Controls compatible for code compliance and energy savings
- Low W/ft² ratio typically meets most restrictive lighting power density codes
- Fixed output, step dimming or 0-10V dimming drivers
- Electrical components accessible from below the ceiling with modular replaceability
- Five year warranty

PROJECT INFORMATION

Project Name _____

Type _____

Catalog No. _____

Date _____

CONSTRUCTION

Luminaire housing and end caps are die formed code gauge cold rolled steel. Reflector is stiffened with linear forms, profiled to a precision curve. High transmission extruded acrylic enclosed lens features linear prisms custom frost for high efficacy without pixelation.

SHIELDING

Thermoplastic light seals snap into the housing at both ends of the lens to prevent light leaks. Lens hinges down for easy access to LED module and electrical components. Optional gasketing available to surround the lamp cavity (standard when Wet Location option is ordered; see footnotes).

FINISH

All reflective surfaces are finished after fabrication with unique formula high reflectivity matte white paint for soft, uniform indirect illumination. Optional Antimicrobial® paint (AM option) resists bacterial growth on exposed painted surfaces.

INSTALLATION

An access plate is furnished with each luminaire for fast wiring access without the necessity to open the fixture or wireway.

CEILING COMPATIBILITY

Luminaire fits recessed exposed Grid ceilings (G); four integral NEC compliant T-bar clips are standard. Can be placed in Slot Grid (SG) style ceiling with regress 3/8" above ceiling plane. A Flange Kit (FK) accessory is available for recessed hard ceiling applications. Surface Mount (SM) option allows placement below ceiling plane. Cable Mount (CM) option allows suspension below ceiling plane.

CERTIFICATION

All luminaires are built to UL 1598 and 2108 standards, and bear appropriate CSA labels. IC label standard. Damp location is standard. Void when using ELL14 and through wiring. Wet location listing available on grid lay-in ceiling type. Emergency-equipped fixtures are Dry Location unless specified. CSA certified to UL 924 standards with battery pack or DTS (Dimming Bypass Module) options. Adheres to LM70, LM80, and TM21 industry standards. The DTS, Dimming Bypass Module, is for emergency circuit control loads including sensors and wireless systems CSA certified to UL 924. See page 4 for wiring diagram.

WARRANTY

Five year warranty (Terms and Conditions apply).

ORDERING INFORMATION

EXAMPLE LTRE24-35MLG-RFA-ESDU

LTRE		24	-		-	RFA	-	U	-
MODEL	COLOR TEMP		CEILING TYPE		SHIELDING		VOLTAGE		OPTIONS
LTRE Transition® Enclosed LED Deep Architectural Center Lens	30 3000K	G Grid Lay-in ²	RFA Ribbed Frosted Acrylic	U 120V-277V	ELL14 Emergency Battery Pack Installed, 1400 Lumens ^{4,5}				
	35 3500K	SM Surface Mount			GLR Fast Blow Fuse	GTD Generator Transfer Device ⁶			
	40 4000K	CM Cable Mount ³			DTS Dimming Bypass Module ⁷	C388 3-Wire Flex			
	50 5000K				C488 4-Wire Flex	C588 5-Wire Flex			
SIZE	LUMEN OUTPUT		DRIVER		AM Antimicrobial® Paint ⁸				
24 2' x 4'	LW Low Watt	E Fixed Output	G1 Lens Gasketing						
	ML Medium Lumen	ED 0-10V Dimming	WL Wet Location ⁵						
	HL High Lumen	ED1 0-10V Dimming up to 1%	EOR End of Row (SM and CM only. Provides end wiring access for continuous row mounting.)						
	VL Very High Lumen	ESD Step Dimming	INT Intermediate (SM and CM only. Provides ends with wiring access for continuous row mounting.)						
	XL Extra High Lumen ¹		CP Chicago Plenum						

¹XL not available with ELL14

²For drywall order FK24 accessories separately

³Order hanger accessories separately

⁴For compatibility with Dual-Lite LiteGear® inverters in lieu of installed battery pack, contact your representative

⁵Not available on Surface Mount or Cable Mount ceiling types

⁶GTD available for E (fixed output) driver option only

⁷For emergency circuit control loads including sensors and wireless systems CSA certified to UL 924. Only available with 0-10V drivers. Not available with XL lumen package. See page 4 for wiring diagram

⁸Optional Antimicrobial® paint (AM option) resists bacterial growth on exposed painted surfaces

PRODUCT AVAILABILITY

SIZE	LUMEN PACKAGE	NOMINAL LUMENS	NOMINAL WATTS	LUMENS PER WATT
24	LW	4275-4875	38	114-130
24	ML	4650-5324	41	112-129
24	HL	5575-6475	52	108-126
24	VL	7225-8250	67	109-124
24	XL	8350-9650	81	103-119

Nominal lumen range represents 3000K through 5000K. Lumens vary according to color temperatures and other factors. See specific photometric test(s).

ACCESSORIES (ORDER SEPARATELY)

- FK24** 2' x 4' Single Flange Kit (Shipped separately)
- CM48Y25C3F-KIT** 48" Cable Mount Kit for 2' wide Cable Mount fixtures, 3 Wire

Test L071409302 Test Date 8/12/2014

PHOTOMETRIC DATA

LUMINAIRE DATA

Luminaire	LTRE24-35MLG-RFA-EDU LTRE Transition® Enclosed LED Deep Architectural Center Lens 2 x 4 led with frosted linear prism lens
Ballast	EVERLINE D15CC55UNVT-C
Ballast Factor	1.00
Lamp	LED
Fixture Lumens	4649
Watts	41.40
Mounting	Recessed
Shielding Angle	0° = 90 90° = 90
Spacing Criterion	0° = 1.19 90° = 1.30
Luminous Opening in Feet	Length: 3.94 Width: 1.85 Height: 0.00

ZONAL LUMEN SUMMARY

Zone	Lumens	% Lamp	% Fixt.
0-30	1198	25.8	25.8
0-40	1961	42.2	42.2
0-60	3496	75.2	75.2
0-90	4649	100.0	100.0
0-180	4649	100.0	100.0

ENERGY DATA

Total Luminaire Efficiency	100.0%
Total Lumens per Watt	112
IESNA RP-1-1993 Compliance	Non-Compliant
Comparative Yearly Lighting Energy Cost per 1000 Lumens	\$2.12 based on 3000 hrs. and \$0.08 per KWH

INDOOR CANDELA PLOT

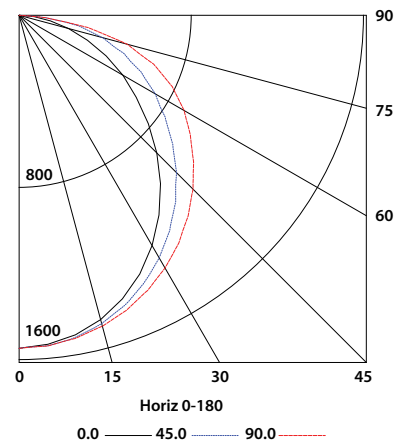

Test L071409304 Test Date 8/13/2014

LUMINAIRE DATA

Luminaire	LTRE24-35VLG-RFA-EDU LTRE Transition® Enclosed LED Deep Architectural Center Lens 2 x 4 led with frosted linear prism lens
Ballast	EVERLINE D23CC90UNVT-F
Ballast Factor	1.00
Lamp	LED
Fixture Lumens	7243
Watts	66.68
Mounting	Recessed
Shielding Angle	0° = 90 90° = 90
Spacing Criterion	0° = 1.18 90° = 1.31
Luminous Opening in Feet	Length: 3.94 Width: 1.85 Height: 0.00

ZONAL LUMEN SUMMARY

Zone	Lumens	% Lamp	% Fixt.
0-30	1886	26.0	26.0
0-40	3087	42.6	42.6
0-60	5502	76.0	76.0
0-90	7243	100.0	100.0
0-180	7243	100.0	100.0

ENERGY DATA

Total Luminaire Efficiency	100.0%
Total Lumens per Watt	109
IESNA RP-1-1993 Compliance	Non-Compliant
Comparative Yearly Lighting Energy Cost per 1000 Lumens	\$2.02 based on 3000 hrs. and \$0.08 per KWH

INDOOR CANDELA PLOT

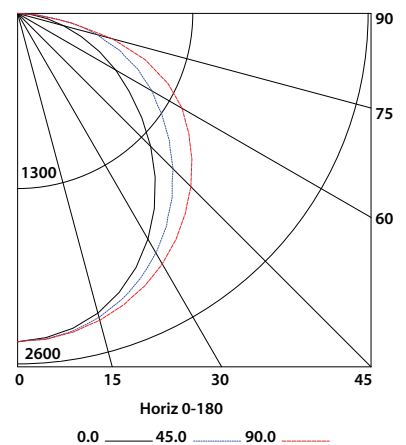

Test L071409305 Test Date 8/13/2014

LUMINAIRE DATA

Luminaire	LTRE24-35XLG-RFA-EDU LTRE Transition® Enclosed LED Deep Architectural Center Lens 2 x 4 led with frosted linear prism lens
Ballast	EVERLINE D23CC90UNVT-F
Ballast Factor	1.00
Lamp	LED
Fixture Lumens	8353
Watts	81.23
Mounting	Recessed
Shielding Angle	0° = 90 90° = 90
Spacing Criterion	0° = 1.19 90° = 1.31
Luminous Opening in Feet	Length: 3.94 Width: 1.85 Height: 0.00

ZONAL LUMEN SUMMARY

Zone	Lumens	% Lamp	% Fixt.
0-30	2146	25.7	25.7
0-40	3513	42.1	42.1
0-60	6271	75.1	75.1
0-90	8353	100.0	100.0
0-180	8353	100.0	100.0

ENERGY DATA

Total Luminaire Efficiency	100.0%
Total Lumens per Watt	103
IESNA RP-1-1993 Compliance	Non-Compliant
Comparative Yearly Lighting Energy Cost per 1000 Lumens	\$2.33 based on 3000 hrs. and \$0.08 per KWH

INDOOR CANDELA PLOT

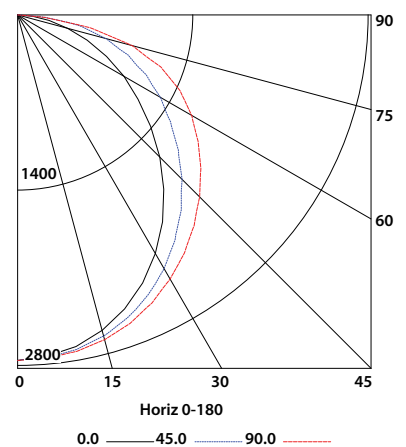

DIMENSIONAL DATA — GRID

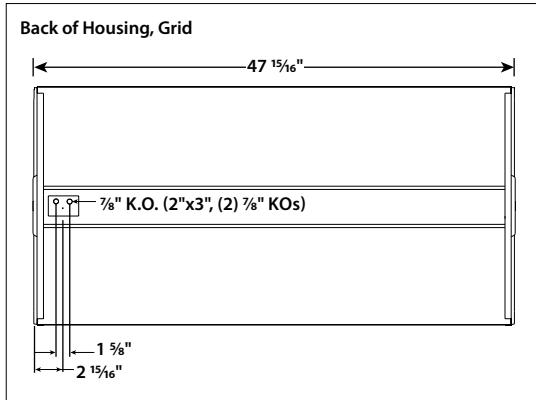
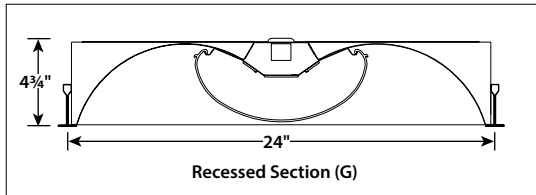

CEILING COMPATIBILITY

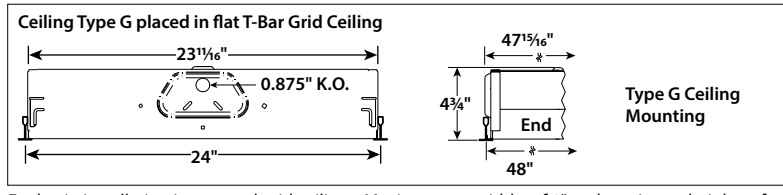

For lay-in installation in exposed grid ceilings. Maximum tee widths of 1" and maximum heights of 1 1/2" allowed.

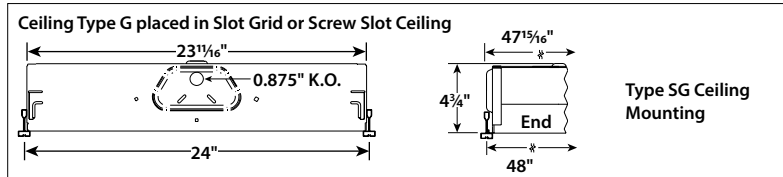

For 3/8" slot grid type ceilings. Luminaire will be regressed 3/8" from the horizontal surface of the tee.

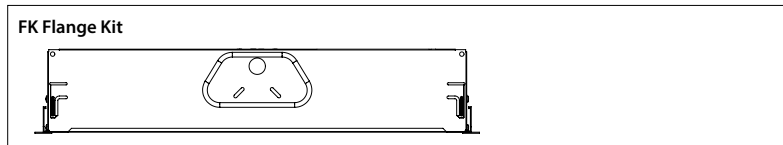

For hard ceiling applications, fixtures must be ordered with a flange kit that wires directly into the concealed ceiling opening for a clean finished appearance. For row configurations contact your local Columbia Representative.

Flange kit cut out dimension for single FK24: 24 3/8" x 48 3/8"

DIMENSIONAL DATA — SURFACE MOUNT

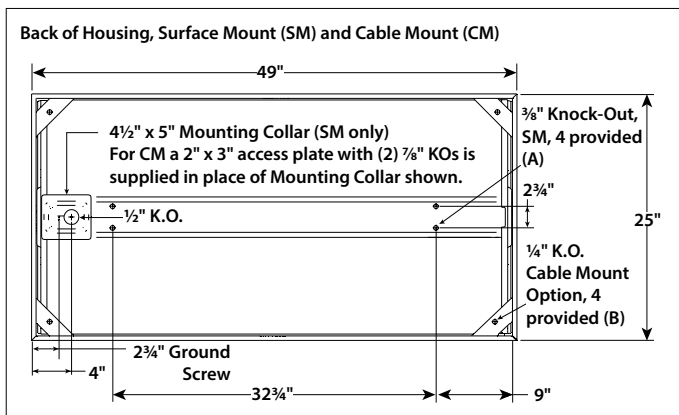
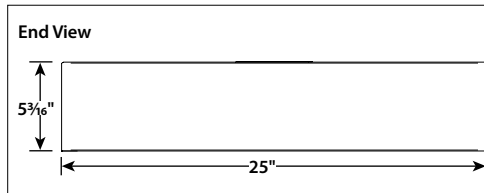
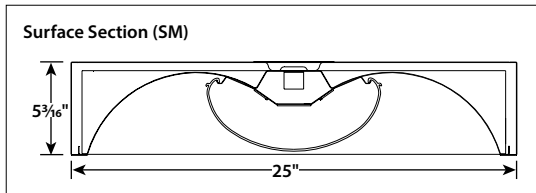

Surface Mount:
Order SM ceiling type. Mounting collar required for surface mounting. (4) Mounting knock-outs, 3/8", provided in center channel as indicated at left, marked "A".

Cable Mount:
Order CM ceiling type. Use CM48Y2SC3F-KIT 48" Cable Mount Kit for 2' wide SM trim fixtures. Mounting holes are provided in diagonal straps shown at left, marked "B".

NOTE: All dimensions are in inches; dimensions and specifications are subject to change without notice. Please consult factory or check sample for verification.

DTS WIRING DIAGRAM (0-10V DIMMING DRIVER SHOWN)

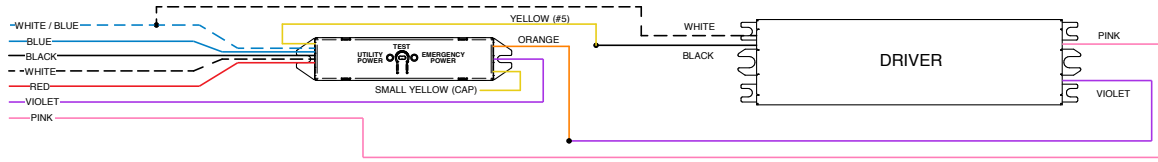

WHITE/BLUE	Emergency Neutral
BLUE	Emergency Line
BLACK	Utility Line (Unswitched Hot)
WHITE	Utility Neutral
RED	Switched Hot
VIOLET	Dimming
PINK	Dimming