

# NOR-2.5R

NONI 2.5" ROUND RECESSED FAMILY

DATE: \_\_\_\_\_ LOCATION: \_\_\_\_\_

TYPE: \_\_\_\_\_ PROJECT: \_\_\_\_\_

CATALOG #: \_\_\_\_\_

## FEATURES

- Downlight (two styles), Lensed Wall Wash (two styles), Adjustable Accent
- ¼" overlap microflange and Flush Mount trims featuring CorrectCut
- Cast aluminum, magnetically-attached reflectors with applied finishes
- Interchangeable primary optics for Downlight and Adjustable Accent
- New Construction Non-IC, IC & Chicago Plenum applications
- Up to 1700 delivered lumens @ 80 CRI 3000K
- 90 CRI (27, 30, 35, 40K); 80 CRI (30, 35K)

*Noni*™



## CONTROLS



## SPECIFICATIONS

### HOUSING CONSTRUCTION

- Formed 22GA steel housing, finished matte black. New Construction (NHN) housing thermally protected. Insulation must be 3" away from housing. New Construction IC (NHI) inherently protected for direct contact with insulation installation
- Removable cover plates on housing side and bottom for j-box inspection
- Downlight (DL) & Shallow Lensed Wall Wash (LWS) feature ultra shallow 2" deep housing. Integral j-box has (4) 7/8" knock-outs
- Adjustable Accent (AA) & Deep Lensed Wall Wash (LWD) utilize 3 3/8" deep housing. Integral j-box has (6) 7/8" knock outs
- Universal adjustable mounting brackets accept 0.5" EMT conduit or 1.5" or 0.75" lathing channel (by others)
- Optional Residential Mounting Bars (RMB) extend from 16–24"
- CorrectCut design is a rolled sheet metal edge which serves as a cutting guide for installers. Provides fixed cutout outer diameter which ensures reliable flange coverage and clean, finished appearance. *KV-exclusive*
- LED protection plate pre-installed from factory
- Control options require above ceiling access

### TRIM CONSTRUCTION

- Reflector assembly includes reflector collar & reflector insert. Both cast aluminum, matte finish. Can be mixed/matched as desired. Insert attaches to collar via magnets. Gasket centers insert and prevents light leak
- ¼" overlap flange. Thickness measures .047"
- Ceiling thickness range 5/8"- 1¼". Two Downlight trim ceiling thickness options available: Shallow (DS) optimized for 5/8" ceiling (compatible up to & including 1 1/8"). Deep (DD) optimized for 1¼" ceiling (compatible with 1¼" only)
- Flush Mount (FT) mud-in ring is low profile, die-cast featuring an edge to plaster up to. Ring attaches to ceiling and comes with removable protective plug installed at factory

### OPTICS

- Low profile, high efficiency polycarbonate TIR primary optics for (DL) and (AA) functions
- Optics installed and serviceable from below through housing aperture
- Media holder included standard. Accepts 1 reflector accessory. Matte black finish, reduces visual brightness at top of trim
- Adjustable Accent (AA) lockable hot-aim 0°–40° vertical tilt, 362° horizontal rotation. Features translating center beam at finished ceiling plane (5/8")
- Two wall wash options, both optimized for 18" spacing off-wall with 2:1 spacing. LWD optic provides industry-leading horizontal uniformity near top-of-wall. LWS optic provides excellent vertical uniformity in ultra shallow housing

### ELECTRICAL

- Integral LED module and driver are field serviceable from below through housing aperture
- Chip-on-board LED. 2 SDCM CCT consistency for static white options. 3 SDCM consistency for Dynamic options
- LED rated life L85 @ 55,000 hours (TM-21)
- Integral solid state constant current dimming driver. 1% and Dim-to-Dark options for 0–10V, ELV and TRIAC controls. NX or Lutron Vive control options available
- Drivers are UL Class 2, inherent short circuit and overload protection. RoHS compliant

### CERTIFICATIONS

- cULus certified to UL 1598
- Suitable for wet locations
- Hexcel Louver (HEX) and No Lens (NON) suitable for damp locations.
- City of Chicago Environmental Air (CCEA / CP)
- Install in environments where ambient temperature does not exceed 25°C

### WARRANTY

- 5 year warranty

KEY DATA	
Wattages	10, 17, 25
Beam Spreads	25, 30, 35, 55, 75
SDCM	2
Rated Life	L85 @ > 55,000 Hours

# NOR-2.5R

NONI 2.5" ROUND RECESSED FAMILY

## ORDERING GUIDE

Examples: NOR-2.5RDL-NHN17-930K-MD-DM1NU / NOR-2.5RDS-TRM-FWHS-RBL-SOL

CATALOG #

### HOUSING

NOR-2.5R					
Series	Function	Housing	Output	CRI/CCT	Beam Spread <sup>2</sup>
NOR-2.5R Noni Recessed 2.5" Round	<b>Shallow Housing (2" Depth)</b>	<b>NHN</b> New Construction, Non-IC <b>NHI</b> New Construction, IC <sup>1</sup> <b>CP</b> Chicago Plenum <sup>1</sup>	<b>10</b> 10 Watt <b>17</b> 17 Watt <b>25</b> 25 Watt	<b>927K</b> 90 CRI, 2700K <b>930K</b> 90 CRI, 3000K <b>935K</b> 90 CRI, 3500K <b>940K</b> 90 CRI, 4000K <b>830K</b> 80 CRI, 3000K <b>835K</b> 80 CRI, 3500K	<b>VN</b> Very Narrow (.44 SC / 25°) <b>NR</b> Narrow (.48 SC / 30°) <b>MD</b> Medium (.56 SC / 35°) <b>WD</b> Wide (.82 SC / 55°) <b>XW</b> Extra Wide (1.10 SC / 75°) <sup>3</sup> <b>LW</b> Lensed Wall Wash <sup>4</sup>
	<b>DL</b> Downlight				
	<b>LWS</b> Lensed Wall Wash, Shallow				
	<b>Shallow Housing (3" Depth)</b>				
	<b>LWD</b> Lensed Wall Wash, Deep				
	<b>AA</b> Adjustable Accent				

Dimming		Controls <sup>13</sup>		U Voltage	Accessories
<b>DM1</b>	0–10V 1% <sup>5, 14, 15</sup>	<b>N</b>	None	<b>U</b> Universal Voltage (120–277V)	<b>RMB</b> Residential Mounting Bars
<b>PDM</b>	ELV, TRIAC 1% <sup>5, 15</sup>	<b>LV</b>	Lutron Vive 0–10V (120–277V)		
<b>ERP</b>	0–10V, ELV, TRIAC Dim-to-Dark <sup>5, 15</sup>	<b>NXE</b>	NX Dual RJ45 SmartPORTS, without Sensor <sup>15</sup>		
		<b>NXW</b>	NX Networked Wireless Radio Module NXRM2 and Bluetooth Programming, without Sensor <sup>15</sup>		

### TRIM

NOR-2.5R		TRM	Reflector Flange Color		Reflector Insert Color	Lens
Series	Function	Trim	Flanged	Flush Mount	Texture	
NOR-2.5R Noni Recessed 2.5" Round	<b>Shallow Housing Compatible</b>	TRM Trim	<b>FWHS</b> White	<b>FT</b> Flush Mount	<b>RWH</b> White	<b>SOL</b> Solite <sup>5</sup> <b>CLR</b> Clear <sup>5</sup> <b>FRS</b> Frosted <sup>6</sup> <b>LIN</b> Linear Spread (10 x 40°) <sup>5, 7</sup> <b>HEX</b> Hexcel Louver <sup>5, 8</sup> <b>NON</b> No Lens <sup>5, 7</sup>
	<b>DS</b> Downlight, Shallow (¾"–1½" ceiling)		<b>FGYS</b> Gray		<b>RGY</b> Gray	
	<b>DD</b> Downlight, Deep (1¼" ceiling only)		<b>FBLS</b> Black		<b>RBL</b> Black	
	<b>LWS</b> Lensed Wall Wash, Shallow		<b>FCOS</b> Copper		<b>RGT</b> Graphite	
	<b>Deep Housing Compatible</b>		<b>FAMW</b> Anti-Microbial White		<b>RPP</b> Pink Panache	
	<b>LWD</b> Lensed Wall Wash, Deep		<b>FX</b> Custom Finish		<b>RGH</b> Grasshopper	
<b>AA</b> Adjustable Accent		<b>Smooth</b>				
		<b>Other</b>				
			<b>RWHS</b> White		<b>RX</b> Custom Finish	
			<b>RGYS</b> Gray			
			<b>RBLS</b> Black			
			<b>RCOS</b> Copper			
			<b>RAMW</b> Anti-Microbial White			

- Notes:
- Available in 10 or 17 watt outputs
  - DL performance based on SOL lens with RWHS insert finish
  - Available only with FRS lens
  - Available only when LW function is selected
  - Available only with DL and AA functions
  - Available with all functions. Must be selected with LWS and LWD
  - Available with DS only
  - HEX and NON suitable for damp location only
  - Above ceiling access required
  - Only available in 17 or 25 watt outputs
  - DM1 or ERP required with NX options

# NOR-2.5R

NONI 2.5" ROUND RECESSED FAMILY

DATE: \_\_\_\_\_ LOCATION: \_\_\_\_\_

TYPE: \_\_\_\_\_ PROJECT: \_\_\_\_\_

CATALOG #: \_\_\_\_\_

## PERFORMANCE DATA

Performance data provided below based on 80 CRI, 3000K with White reflector and Solite lens. Extra Wide (XW) and Lensed Wall Wash (LWS, LWD) performance includes White reflector and Frosted lens.

Output	Beam Spread	Beam	Delivered Lumens	Efficacy	Spacing Criterion	Candela @ 0°
25 Watt	Very Narrow (VN)	25	1626	64	0.44	5884
	Narrow (NR)	30	1563	62	0.48	4844
	Medium (MD)	35	1435	57	0.56	3438
	Wide (WD)	55	1734	69	0.82	2200
	Extra Wide (XW)	75	1186	47	1.10	844
17 Watt	Very Narrow (VN)	25	1227	71	0.44	4472
	Narrow (NR)	30	1180	68	0.48	3682
	Medium (MD)	35	1084	63	0.56	2613
	Wide (WD)	55	1309	76	0.82	1672
	Extra Wide (XW)	75	895	52	1.10	641
10 Watt	Very Narrow (VN)	25	762	75	0.44	2771
	Narrow (NR)	30	733	72	0.48	2282
	Medium (MD)	35	673	66	0.56	1619
	Wide (WD)	55	813	80	0.82	1036
	Extra Wide (XW)	75	556	55	1.10	397

Output		Delivered Lumens	Efficacy	Max Candela
25 Watt	Wall Wash, Shallow (LWS)	914	36	649
	Wall Wash, Deep (LWD)	914	36	929
17 Watt	Wall Wash, Shallow (LWS)	690	40	493
	Wall Wash, Deep (LWD)	690	40	706
10 Watt	Wall Wash, Shallow (LWS)	429	42	306
	Wall Wash, Deep (LWD)	429	42	438

# NOR-2.5R

NONI 2.5" ROUND RECESSED FAMILY

## MULTIPLIER TABLE

CRI, CCT	927	930	935	940	830	835					
	0.83	0.86	0.87	0.87	1.0	1.02					
Media	SOL	CLR	LIN	HEX	FRS	NON					
	1.0	1.02	0.91	0.71	0.73	1.12					
Output	10 Watt	17 Watt	25 Watt								
	0.47	0.76	1.0								
Finishes	RWH	RGY	RBL	RGT	RPP	RGH	RWHS	RGYS	RGBLS	RCOS	RAMW
	1.0	0.9	0.85	0.85	0.8	0.8	1.02	0.95	0.9	0.8	1.05

## ELECTRICAL DATA

	DM1	PDM	ERP
Dimming Protocols Supported	0-10V	ELV, TRIAC	0-10V, ELV, TRIAC
Input Voltage	120-277V	120-277V	120-277V
Input Frequency	50/60 Hz	50/60 Hz	50/60 Hz
Dim Level	20W <1% 17W <5%	1%	1% Dim-to-Dark
Power Factor (PF)	≥0.90	≥0.90	≥0.90
Total Harmonic Distortion (THD)	<20%	<20%	<20%
Inrush Current	NEMA 410 Limit	NEMA 410 Limit	NEMA 410 Limit
Electromagnetic Interference (EMI) Filtering	FCC CFR Title 47 Part 15 Class B	FCC CFR Title 47 Part 15 Class B	FCC CFR Title 47 Part 15 Class B at 120Vac, Class A at 277Vac
Transient Surge Protection	IEEE C62.411-2002 & C62.412-2002 Category A	IEEE C62.411-2002 & C62.412-2002 Category A	IEEE C62.411-2002 & C62.412-2002 Category A

# NOR-2.5R

NONI 2.5" ROUND RECESSED FAMILY

DATE: \_\_\_\_\_ LOCATION: \_\_\_\_\_

TYPE: \_\_\_\_\_ PROJECT: \_\_\_\_\_

CATALOG #: \_\_\_\_\_

## DIMENSIONS

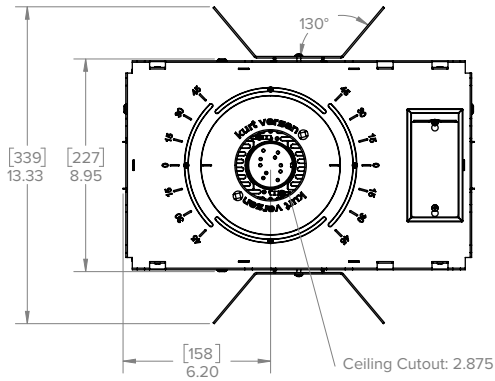

Housing

Shallow Housing (DL, LWS)

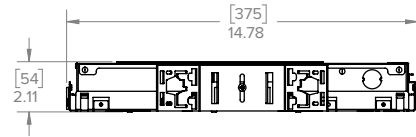

Deep Housing (LWD, AA)

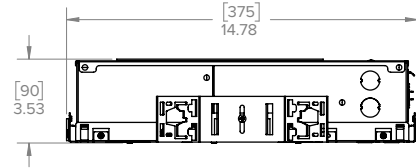

Flange

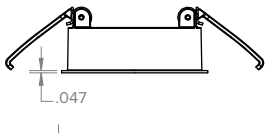

Flush Mount (FT)

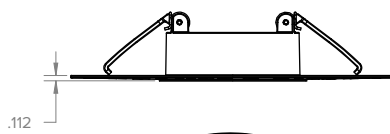

Flush Mount (FT) with Downlight, Shallow (DS)

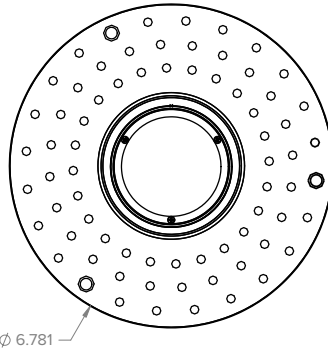
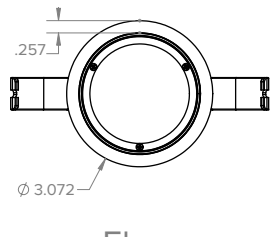
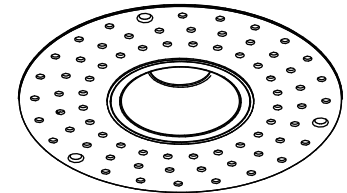

Reflector Collar

Downlight (DS)

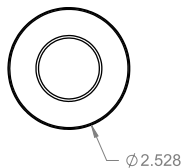
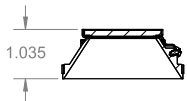

DownLight, Deep (DD)

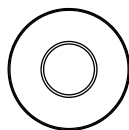
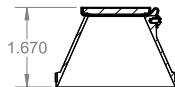

Lensed Wall Wash Shallow (LWS)

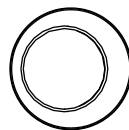
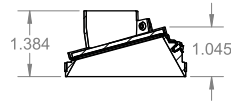

Lensed Wall Wash Deep (LWD)

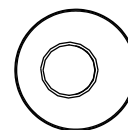

Adjustable (AA)

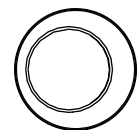
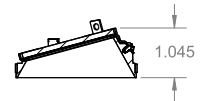

Reflector Insert