

AAL Poles

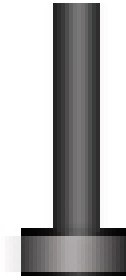

SPECIFICATIONS

APPLICATIONS

- Lighting installations for side and top mounting of luminaires with effective projected area (EPA) not exceeding maximum allowable loading of the specified pole in its installed geographic location

CONSTRUCTION

- SHAFT: One-piece tapered aluminum with round cross section, made of 6061-T6 shaft and 356-T6 cast aluminum base

GROUP 1

- ANCHOR BOLTS: Supplied with (3) galvanized anchor bolts with minimum yield of 55,000 psi (ASTM F1554). Galvanized hardware with two washers and two nuts per bolt for leveling. Top nut is acorn nut.
- POLE CAP: 3" pole top standard; Supplied with removable cover when applicable; Tenon configurations also available
- HANDHOLE: 2" X 4" handhole opening with cover grounding provision provided opposite handhole opening. The handhole is located 18" from the base of the pole.

GROUP 2

- ANCHOR BOLTS: Supplied with (4) galvanized anchor bolts with minimum yield of 55,000 psi (ASTM F1554). Galvanized hardware with two washers and two nuts per bolt for leveling
- BOLT COVER: Four individual bolt covers provided

- POLE CAP: Pole shaft supplied with removable cover when applicable; Tenon and post-top configurations also available
- HANDHOLE: 4" X 6" handhole opening with cover and grounding provision handhole 3" x 5" for 20' pole. The handhole is located 18" from the base of the pole

FINISH

- Durable thermoset polyester powder coat paint finish with nominal 3.0 mil thickness
- Decorative finish coat available in multiple standard colors; Custom colors available, RAL number preferred

ORDERING GUIDE

Example: RSS-A-10-40-A-1-BLT-GFI-VM2

CATALOG #

POLE

| Series | Height | Shaft | Thickness | Mounting | Finish | Options |
|-----------------------------------|----------------------------------|----------------------------------|----------------------------------|---|---|---|
| RTA-A Round Tapered Aluminum Pole | Reference page 2 Ordering matrix | Reference page 2 Ordering matrix | Reference page 2 Ordering matrix | TA Tenon (2.375" OD) TB Tenon (2.875" OD) TC Tenon (3.5" OD) OT Open top (includes pole cap) | BLS Black Gloss Smooth BLT Black Matte Textured DBS Dark Bronze Gloss Smooth DBT Dark Bronze Matte Textured GTT Graphite Matte Textured LGS Light Grey Gloss Smooth LGT Light Grey Matte Textured PSS Platinum Silver Gloss Smooth VGT Verde Green Matte Textured WHS White Gloss Smooth WHT White Matte Textured Color Option CC¹ Custom Color | GFI 20 Amp GFCI Receptacle and Cover EHH Extra Handhole C05 .5" Coupling C07 .75" Coupling C20 2" Coupling VM2 2nd mode vibration damper LAB Less Anchor Bolts |

| Accessories | |
|-------------|---|
| VM2SXX | 2nd mode vibration damper, ordered separately |

Notes:

1 Consult factory for custom color, marine and corrosive finish

PRODUCTS EXCEPTIONS & DETAILS

ORDERING MATRIX

| Catalog Number | Height | | Nominal Shaft Dimensions | Wall Thickness | Bolt Circle (suggested) | Bolt Circle (range) | Base Plate Size | Base Plate Shape | Anchor bolt size | Bolt Projection | Pole weight |
|----------------|--------|--------|--------------------------|----------------|-------------------------|---------------------|-----------------|------------------|------------------|-----------------|-------------|
| | Feet | Meters | | | | | | | | | |
| Group 1 | | | | | | | | | | | |
| RTA-A-10-40-A | 10 | 3.0 | 4" x 3" | 0.125" | 7" | - | 7.25" | Triangular | 3/4" x 30" x 3" | 3.5" | 24 |
| RTA-A-12-40-A | 12 | 3.7 | 4" x 3" | 0.125" | 7" | - | 7.25" | Triangular | 3/4" x 30" x 3" | 3.5" | 27 |
| RTA-A-14-40-A | 14 | 4.3 | 4" x 3" | 0.125" | 7" | - | 7.25" | Triangular | 3/4" x 30" x 3" | 3.5" | 32 |
| RTA-A-16-50-A | 16 | 4.9 | 5" x 3" | 0.125" | 8" | - | 8.31" | Triangular | 3/4" x 30" x 3" | 3.5" | 35 |
| RTA-A-18-50-A | 18 | 5.5 | 5" x 3" | 0.125" | 8" | - | 8.31" | Triangular | 3/4" x 30" x 3" | 3.5" | 42 |
| RTA-A-20-50-A | 20 | 6.1 | 5" x 3" | 0.125" | 8" | - | 8.31" | Triangular | 3/4" x 30" x 3" | 3.5" | 47 |
| Group 2 | | | | | | | | | | | |
| RTA-A-20-60-B | 20 | 6.1 | 6" x 4" | 0.188" | 9" | 9" - 10" | 9.75" | Square | 1" x 36" x 4" | 4.25" | 90 |
| RTA-A-25-70-B | 25 | 7.6 | 7" x 4" | 0.188" | 11" | 10" - 11" | 10.5" | Square | 1" x 36" x 4" | 4.25" | 120 |
| RTA-A-30-80-B | 30 | 9.1 | 8" x 4.5" | 0.188" | 11" | 11" - 12" | 11.25" | Square | 1" x 36" x 4" | 4.25" | 150 |
| RTA-A-35-80-C | 35 | 10.7 | 8" x 4.5" | 0.250" | 11" | 11" - 12" | 11.25" | Square | 1" x 36" x 4" | 4.25" | 205 |
| RTA-A-40-80-C | 40 | 12.2 | 8" x 4.5" | 0.250" | 11" | 11" - 12" | 11.25" | Square | 1" x 36" x 4" | 4.25" | 260 |

MOUNTING ORIENTATION

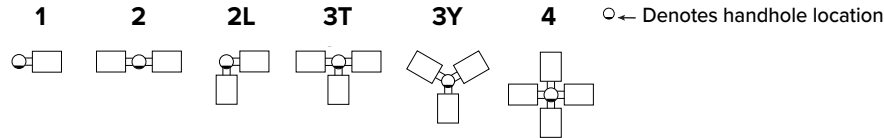

PRODUCTS EXCEPTIONS & DETAILS (CONTINUED)

PRODUCT DETAILS

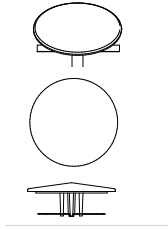

Pole Cap

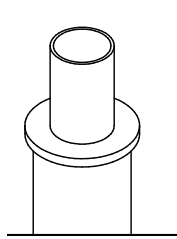

Tenan

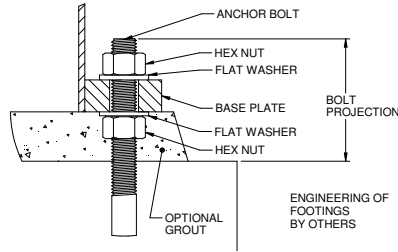

Base Detail

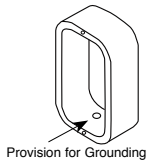

Provision for Grounding

EHH - Extra Handhole

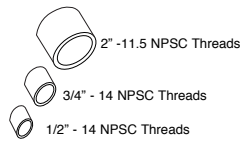

C05 - C07 - C20 - Coupling

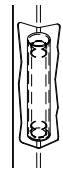

VM2 - Vibration Damper 2nd Mode

Factory installed, internal damper designed to alter pole resonance to reduce movement and material fatigue caused by 2nd vibration.

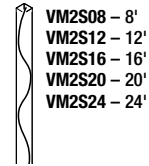

VM2SXX - Vibration Damper 2nd Mode

Factory installed, internal damper designed to alter pole resonance to reduce movement and material fatigue caused by 2nd vibration.

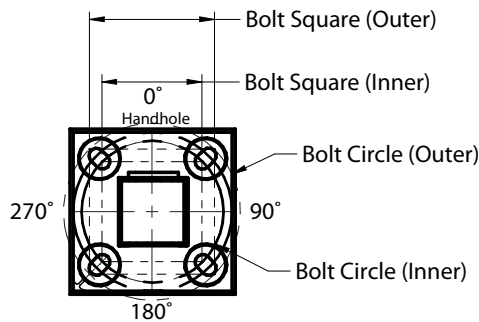
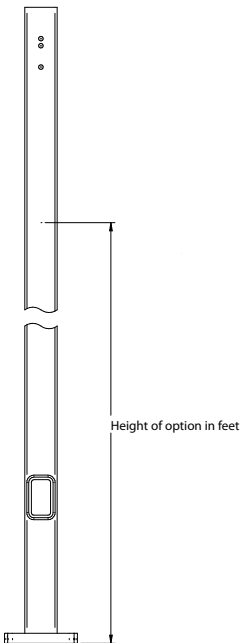

OPTION ORIENTATION

- Follow the logic below when ordering location specific options. For each option, include its orientation (in degrees) and its height (in feet). Example: Option C07 should be ordered as: RSS-A-20-60-B-OT-DBS-CO5-0-15 (.5" coupling on the handhole/arm side of pole, 15 feet up from the pole base) 1' spacing required between option. Consult factory for other configurations.

NOTE: Factory supplied template must be used when setting anchor bolts. Current Lighting will deny any claim for incorrect anchorage placement resulting from failure to use factory supplied template and anchor bolts.

PRODUCTS EXCEPTIONS & DETAILS (CONTINUED)

ASCE7-05 WIND MAP

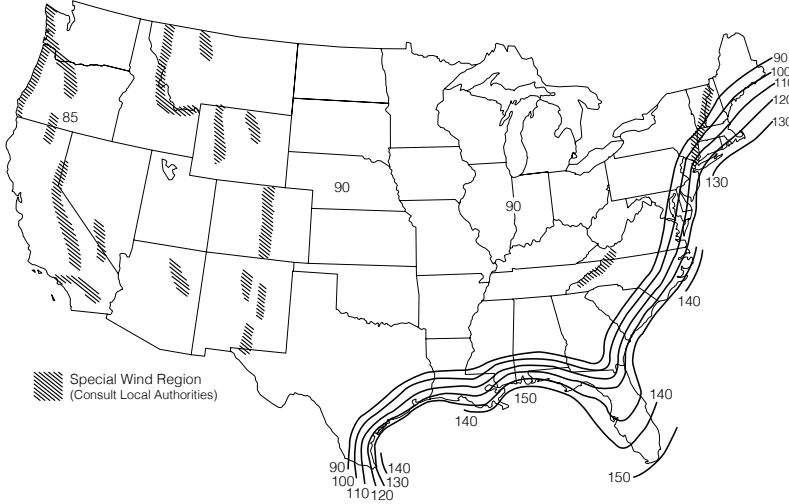

*PRINTED WITH PERMISSION FROM ASCE

HAWAII – 105 mph
PUERTO RICO – 145 mph

FLORIDA REGION WIND MAP

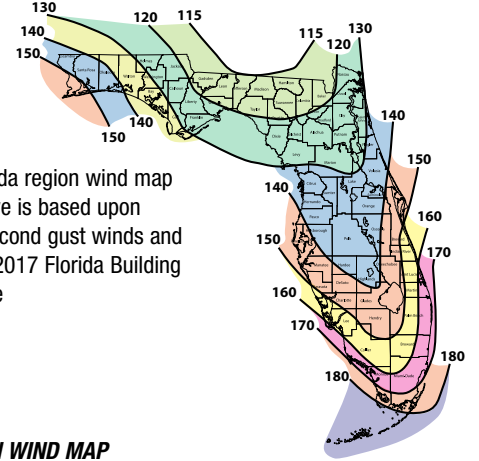

- Florida region wind map above is based upon 3-second gust winds and the 2017 Florida Building Code

ALASKA REGION WIND MAP

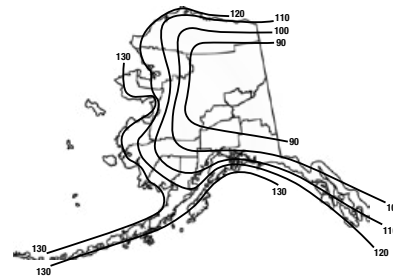

| ASCE 7-05 wind map EPA Load Rating - 3 second gust wind speeds | | | | | | | | | |
|--|--------|------|------|-----|-----|-----|-----|-----|-----|
| Catalog Number | Height | 85 | 90 | 100 | 110 | 120 | 130 | 140 | 150 |
| Group 1 | | | | | | | | | |
| RTA-A-10-40-A | 10 | 11.4 | 10.0 | 7.8 | 6.2 | 5.0 | 4.0 | 3.4 | 2.8 |
| RTA-A-12-40-A | 12 | 9.0 | 7.8 | 6.0 | 4.6 | 3.6 | 2.8 | 2.2 | 1.8 |
| RTA-A-14-40-A | 14 | 7.0 | 6.0 | 4.4 | 3.4 | 2.4 | 1.8 | 1.4 | 1.0 |
| RTA-A-16-50-A | 16 | 9.8 | 8.6 | 6.4 | 4.8 | 3.8 | 3.0 | 2.4 | 2.0 |
| RTA-A-18-50-A | 18 | 8.0 | 6.8 | 4.8 | 3.6 | 2.8 | 2.0 | 1.6 | 1.2 |
| RTA-A-20-50-A | 20 | 6.2 | 5.2 | 3.6 | 2.4 | 1.8 | 1.2 | nr | nr |
| Group 2 | | | | | | | | | |
| RTA-A-20-60-B | 20 | 15.0 | 12.8 | 9.9 | 7.8 | 6.2 | 5.0 | 4.2 | 3.5 |
| RTA-A-25-70-B | 25 | 14.5 | 12.5 | 9.4 | 7.2 | 5.5 | 4.5 | 3.7 | 3.0 |
| RTA-A-30-80-B | 30 | 13.9 | 11.8 | 8.7 | 6.6 | 5.2 | 4.1 | 3.3 | 2.6 |
| RTA-A-35-80-C | 35 | 12.8 | 10.5 | 7.6 | 5.6 | 4.3 | 3.4 | 2.6 | 1.9 |
| RTA-A-40-80-C | 40 | 8.6 | 6.9 | 4.4 | 2.8 | 1.9 | 1.2 | nr | nr |

| Florida Building Code 2017 EPA Load Rating - 3 second gust wind speeds | | | | | | | | |
|--|------|------|-----|-----|-----|-----|-----|-----|
| Catalog Number | 115 | 120 | 130 | 140 | 150 | 160 | 170 | 180 |
| Group 1 | | | | | | | | |
| RTA-A-10-40-A | 10.2 | 9.2 | 7.6 | 6.4 | 5.4 | 4.6 | 3.8 | 3.4 |
| RTA-A-12-40-A | 8.0 | 7.0 | 5.8 | 4.8 | 4.0 | 3.2 | 2.6 | 2.2 |
| RTA-A-14-40-A | 6.2 | 5.4 | 4.4 | 3.6 | 2.8 | 2.2 | 1.8 | 1.4 |
| RTA-A-16-50-A | 8.8 | 7.8 | 6.2 | 5.2 | 4.2 | 3.4 | 2.8 | 2.4 |
| RTA-A-18-50-A | 6.8 | 6.0 | 4.8 | 3.8 | 3.0 | 2.4 | 2.0 | 1.6 |
| RTA-A-20-50-A | 5.4 | 4.6 | 3.4 | 2.6 | 2.0 | 1.6 | 1.2 | nr |
| Group 2 | | | | | | | | |
| RTA-A-20-60-B | 10.2 | 9.0 | 8.8 | 7.3 | 6.0 | 4.9 | 4.0 | 3.3 |
| RTA-A-25-70-B | 11.7 | 10.5 | 8.4 | 6.8 | 5.4 | 4.4 | 3.5 | 2.7 |
| RTA-A-30-80-B | 11.2 | 9.9 | 7.8 | 6.1 | 4.7 | 3.5 | 2.6 | 1.8 |
| RTA-A-35-80-C | 10.6 | 9.3 | 7.1 | 5.4 | 4.0 | 2.9 | 1.9 | 1.1 |
| RTA-A-40-80-C | 7.5 | 6.4 | 4.5 | 3.1 | 1.9 | 1.0 | nr | nr |

| | |
|------------|-----------|
| DATE: | LOCATION: |
| TYPE: | PROJECT: |
| CATALOG #: | |

PRODUCTS EXCEPTIONS & DETAILS (CONTINUED)

WIND-SPEED WEBSITE DISCLAIMER:

- Allowable EPA, to determine max pole loading weight, multiply allowable EPA by 30 lbs.
- The tables for allowable pole EPA are based on the ASCE 7-05 Wind Map or the Florida Region Wind Map for the 2017 Florida Building Code. The Wind Maps are intended only as a general guide and cannot be used in conjunction with other maps. Always consult local authorities to determine maximum wind velocities, gusting and unique wind conditions for each specific application
- Allowable pole EPA for jobsite wind conditions must be equal to or greater than the total EPA for fixtures, arms, and accessories to be assembled to the pole. Responsibility lies with the specifier for correct pole selection. Installation of poles without luminaires or attachment of any unauthorized accessories to poles is discouraged and shall void the manufacturer's warranty
- Wind speeds and listed EPAs are for ground mounted installations. Poles mounted on structures (such as bridges and buildings) must consider vibration and coefficient of height factors beyond this general guide; Consult local and federal standards
- Wind Induced Vibration brought on by steady, unidirectional winds and other unpredictable aerodynamic forces are not included in wind velocity ratings.
- Extreme Wind Events like, Hurricanes, Typhoons, Cyclones, or Tornadoes may expose poles to flying debris, wind shear or other detrimental effects not included in wind velocity ratings

RTA-A Series

ROUND TAPERED ALUMINUM POLE

DATE: _____ LOCATION: _____

TYPE: _____ PROJECT: _____

CATALOG #: _____

DIMENSIONS

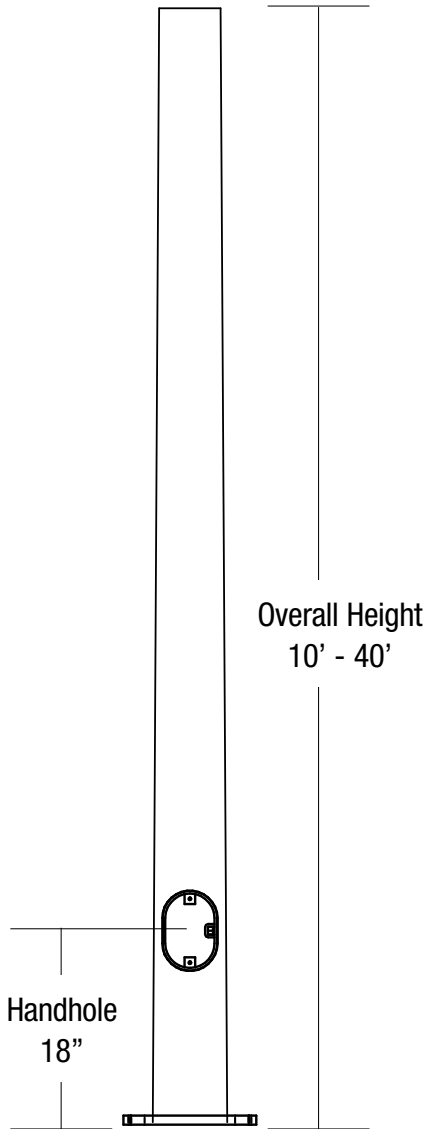

TOP VIEW

