

# AA-56 8" Scroll

ARMS

## SPECIFICATIONS

### CONSTRUCTION

- All cast aluminum parts shall be low copper alloy A356. All extruded aluminum parts shall be alloy 6061-T6, 6063-T5 or equal
- ALL Beacon Decorative Arms mount to an Open Top Pole.

### EPA (EFFECTIVE PROJECTED AREA)

- EPA is defined as (projected surface area X drag factor) and measured in ft<sup>2</sup>. Allowable post, luminaire arm, luminaire and accessory EPAs are derived from the most current published AASHTO (American Association of State Highway and Transportation Officials) standard, currently AASHTO 2001 (50yr design life). Customer assumes all responsibility for selecting the appropriate post for installation (consult factory for assistance). Luminaire arm, luminaire and accessory EPA must be equal to or less than allowable EPA of post. Consult a professional engineer for compliance with local codes and standards

### FASTENERS

- All fasteners shall be Corrosion Resistant. When tamper resistant fasteners are required, spanner HD (snake eye) style shall be provided (special tool required, available at additional cost)

### FINISH

- Finish shall be a Beacote V polyester powder-coat electro-statically applied and thermocured. Beacote V finish shall consist of a five stage iron phosphate chemical pretreatment regimen with a polymer primer sealer, oven dry off, and top coated with a thermoset super TGIC polyester powder coat finish. The finish shall meet the AAMA 605.2 performance specification which includes passing a 3000 hour salt spray test for corrosion resistance and resists cracking or loss of adhesion per ASTM D522 and resists surface impacts of up to 160 inch-pound

### WARRANTY

- 5 year warranty



## ORDERING GUIDE

Example: AA-56-S-4-B-T-DBT

CATALOG # **AA-56-**

Model	Post Shaft Profile	Post Shaft Diameter	Arrangement	Luminaire Mounting	Color
AA-56 8" Scroll	<b>W</b> Wall Mount <b>S</b> Smooth <b>F</b> Fluted	<b>4</b> 4" <b>5</b> 5" <b>6</b> 6"	See arrangement table below	<b>T</b> Tenon	<b>BLT</b> Black Matte Textured <b>BLS</b> Black Gloss Smooth <b>DBT</b> Dark Bronze Matte Textured <b>DBS</b> Dark Bronze Gloss Smooth <b>GTT</b> Graphite Matte Textured <b>LGS</b> Light Grey Gloss Smooth <b>LGT</b> Light Grey Matte Textured <b>PSS</b> Platinum Silver Smooth <b>WHT</b> White Matte Textured <b>WHS</b> White Gloss Smooth <b>VGT</b> Verde Green Textured <b>Color Option</b> <b>CC</b> Custom Color

## EPA INDEX INFORMATION

		arrangement (EPA index ft <sup>2</sup> / weight (lbs))		
				
shaft Ø		A	B	C
wall	weight	10	-	-
Ø4"	EPA	-	.63	.85
	weight	-	10	15
Ø5"	EPA	-	.73	.95
	weight	-	12	17
Ø6"	EPA	-	.83	1.05
	weight	-	15	20

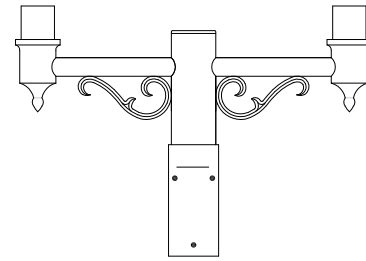

# AA-56 8" Scroll

ARMS

## DETAILS

**ALL Beacon Decorative Arms mount to an Open Top Pole.**

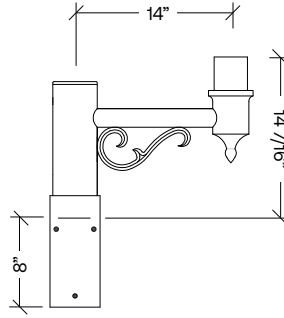
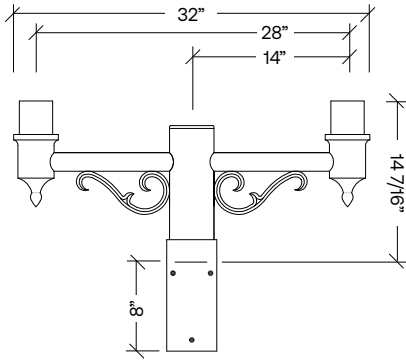

## WALL BRACKET DETAILS

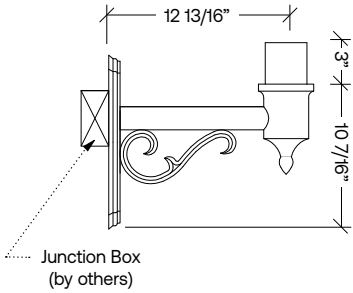

## WALL PLATE DETAILS

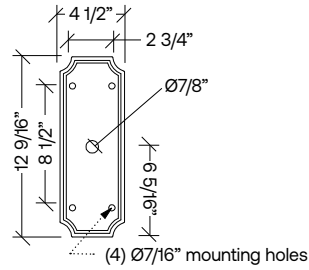

*Due to our continued efforts to improve our products, product specifications are subject to change without notice.*