

**FEATURES**

- Reliable, uniform, glare free illumination
- Types 1, 2, 3, 4W, 5Q, and 5W distributions
- 3000K, 4000K, 5000K CCT
- 0-10V dimming ready
- Integral surge suppression
- Upgrade Kits



**PROMENADE**



Promenade PRMD2

**SPECIFICATIONS**

**CONSTRUCTION**

- All housing components aluminum 360 alloy, sealed with continuous silicone rubber gaskets
- Standard configurations do not require a flat lens, optional lenses is tempered glass
- All internal and external hardware is stainless steel
- Finish: fade and abrasion resistant, electrostatically applied, thermally cured, triglycidal isocyanurate (TGIC) polyester powdercoat
- Optical bezel finish is match the luminaire housing

**LED/OPTICS**

- Optical cartridge system consisting of a die cast heat sink, LED engine, TIR optics, gasket and bezel plate
- Cartridge is easily disassembled to replace components. Optics are held in place without the use of adhesives
- Molded silicone gasket ensures a weather-proof seal around each individual LED
- Features revolutionary individual LED optical control based on high performance TIR optical designs
- House Side Shield is available on Standard and Clear Lens options except any Type 5 distribution. House Side Shield is not available for any distribution using a Diffused Lens

**INSTALLATION**

- Fixtures must be grounded in accordance with national, state and/or local electrical codes. Failure to do so may result in serious personal injury

**ELECTRICAL**

- Luminaires have integral surge protection, UL recognized and have a surge current rating of 10,000 Amps using the industry standard 8/20uSec wave and surge rating of 372J
- Drivers are UL recognized with an inrush current maximum of <20.0 Amps maximum at 230VAC
- 100%-1% dimming range. Fixture will be wired for low voltage 0-10V dimming control

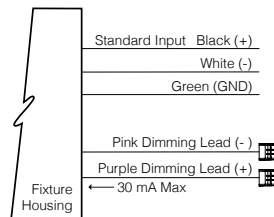

- Driver and surge suppressor are mounted to a prewired tray with quick disconnects that may be removed from the gear compartment

**CERTIFICATIONS**

- ETL listed under UL 1598 and CSA C22.2 No. 250.0-08 for wet locations
- This product qualifies as a “designated country construction material” per FAR 52.225-11 Buy American-Construction Materials under Trade Agreements effective 6/06/2020

**WARRANTY**

- 5 year warranty

KEY DATA	
LUMEN RANGE	5,800-18,500
WATTAGE RANGE	50-159
EFFICACY RANGE (LPW)	95-142
INPUT CURRENT RANGE (mA)	225-700 mA
WEIGHT	34 lbs/15.4 kg
EPA	1.19

**ORDERING GUIDE**

Example: PRMD2-72L-345-5K7-4W-BL-TRA2M-CL-HS-AD5-UNV

CATALOG #

**HOUSING**

PRMD2		LED Quantity		Lumen output		CCT/CRI		Distribution		Finish	
<b>PRMD2</b>	Promenade	<b>72L</b>	72 LED	<b>225</b>	445mA, MicroCore Equivalent	<b>AMB</b>	Amber-595nm Peak <sup>1</sup>	<b>1</b>	Type I	<b>BLS</b>	Black Gloss Smooth
				<b>335</b>	335mA, 8,500 lumens	<b>3K7</b>	3000K, 70 CRI	<b>2</b>	Type II	<b>BLT</b>	Black Matte Textured
				<b>345</b>	700mA, MicroCore Equivalent	<b>4K7</b>	4000K, 70 CRI	<b>3</b>	Type III	<b>DBS</b>	Dark Bronze Gloss Smooth
				<b>500</b>	500mA, 12,000 lumens	<b>5K7</b>	5000K, 70 CRI	<b>4W</b>	Type IV Wide	<b>DBT</b>	Dark Bronze Matte Textured
				<b>700</b>	700mA, 16,000 Lumens			<b>5Q</b>	Type V Square	<b>GTT</b>	Graphite Matte Textured
								<b>5W</b>	Type V Wide	<b>LGS</b>	Light Grey Gloss Smooth
										<b>LGT</b>	Light Grey Matte Textured
										<b>PSS</b>	Platinum Silver Gloss Smooth
										<b>VGT</b>	Verde Green Matte Textured
										<b>WHS</b>	White Gloss Smooth
										<b>WHT</b>	White Matte Textured
										<b>Color Option</b>	
										<b>CC</b> <sup>2</sup>	Custom Color

Mounting	Optional Lens	Options	Voltage
<b>Pole Mount Arms</b> Bolts to a 4"/100mm DIA. or 5"/125mm DIA. pole TRA2M TRA2L TRA5D TRA6D SLA8D SLA22DL SLA3 (4"/100mm DIA. poles only) Slips over a 4"/100mm DIA. pole or tenon TRA4 TRA4-2 TRA7 TRA7-2 TRA8 TRA8-2 TRA9 TRA9-2 SLA4 SLA4-2 SLA9 Slips over a 4"/100mm DIA. pole or tenon SLA7 SLA7-2 SLA17 SLA17-2  <b>Wall Mount</b> WMA2M WMA2L WMA35D WMA36D WMA37 WMA38 WMA39 WMA4 WMA6 WMA8 WMA9D WMA10 WMA11 WMA12 WMA16 WMA17 WMA18 WMA22D  <b>Other Mounting</b> <b>MAT</b> Cast adapter to side mount to a 2 3/8" 61mm DIA. mast arm <b>PMS</b> Pendant mount with 48"/1220 stem, canopy and swivel <b>PMC</b> Pendant mount with 48"/1220mm of brass chain in fixture finish	<b>DL</b> Diffused Lens	<b>HS</b> House Side Shield <b>FTG</b> Flat Glass Lens <b>VSR</b> Visor <b>SF</b> Single Fuse (120,277) <b>DF</b> Double Fuse (208,240)	<b>UNV</b> 120-277V

**DIMENSIONS**

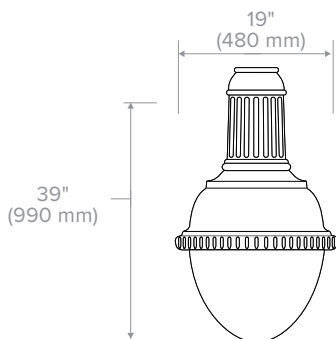

Notes:

- 1 Turtle Friendly
- 2 Consult factory for custom color, marine and corrosive finish options

**DELIVERED LUMENS**

The table below shows the delivered lumens for the various lumen outputs and beam distributions. Use this chart in connection with the lumen factor (LF) capability to deliver any output required.

**LUMINAIRE PERFORMANCE – CLEAR LENS**

LED #	Drive Current	Lumen Package	Lens	Distribution	3000K 70CRI				4000K 70CRI				5000K 70CRI							
					Lumen	Bug Rating			Efficacy (Lm/W)	Lumen	Bug Rating			Efficacy (Lm/W)	Lumen	Bug Rating			Efficacy (Lm/W)	
72	225	Microcore Equivalent	Clear Lens	1	6643	1	3	1	132.9	6861	1	3	1	137.2	7118	1	3	2	142.4	
				2	6097	1	3	2	121.9	6298	1	3	2	126.0	6534	1	3	2	130.7	
				3	6017	1	3	2	120.3	6215	1	3	2	124.3	6448	1	3	2	129.0	
				4W	5939	1	3	2	118.8	6134	1	3	2	122.7	6364	1	3	3	127.3	
				1-HS	3935	0	3	1	78.7	4064	0	3	1	81.3	4216	0	3	1	84.3	
				2-HS	3134	0	3	1	62.7	3237	0	3	1	64.7	3358	0	3	1	67.2	
				3-HS	3079	0	3	1	61.6	3180	0	3	1	63.6	3299	0	3	1	66.0	
				4W-HS	2816	0	3	1	56.3	2909	0	3	1	58.2	3018	0	3	1	60.4	
				5Q	6383	2	3	1	127.7	6593	2	3	1	131.9	6840	2	3	1	136.8	
				5W	5813	3	3	2	116.3	6004	3	3	2	120.1	6229	3	3	2	124.6	
	335	8500			1	9447	1	3	2	125.2	9758	1	3	2	129.3	10123	1	3	2	133.4
					2	8671	2	3	2	114.9	8957	2	3	2	118.7	9292	2	3	2	122.4
					3	8557	2	3	2	113.4	8839	2	3	2	117.1	9170	2	3	2	121.5
					4W	8445	1	3	3	111.9	8723	1	3	3	115.6	9050	1	3	3	120.2
					1-HS	5595	1	3	1	74.2	5780	1	3	1	76.6	5996	1	3	1	79.4
					2-HS	4457	1	3	1	59.1	4604	1	3	1	61.0	4776	1	3	1	63.2
					3-HS	4379	1	3	1	58.0	4523	1	3	1	59.9	4692	1	3	1	62.1
					4W-HS	4005	1	3	1	53.1	4137	1	3	1	54.8	4292	1	3	1	57.3
					5Q	9077	3	3	2	120.3	9376	3	3	2	124.3	9727	3	3	2	129.2
					5W	8266	3	3	2	109.5	8538	3	3	2	113.2	8858	3	3	2	117.6
	345	Microcore Equivalent			1	9649	1	3	2	124.0	9966	1	3	2	128.1	10339	1	3	2	132.9
					2	8857	2	3	2	113.8	9148	2	3	2	117.6	9491	2	3	2	122.0
					3	8740	2	3	2	112.3	9028	2	3	2	116.0	9366	2	3	2	120.4
					4W	8626	1	3	3	110.9	8910	1	3	3	114.5	9243	1	3	3	118.8
					1-HS	5715	1	3	1	73.5	5903	1	3	1	75.9	6124	1	3	1	78.7
					2-HS	4552	1	3	1	58.5	4702	1	3	1	60.4	4878	1	3	1	62.7
					3-HS	4472	1	3	1	57.5	4619	1	3	1	59.4	4792	1	3	1	61.6
					4W-HS	4091	1	3	1	52.6	4225	1	3	1	54.3	4384	1	3	1	56.3
					5Q	9271	3	3	2	119.2	9576	3	3	2	123.1	9935	3	3	2	127.7
					5W	8443	3	3	2	108.5	8721	3	3	2	112.1	9047	3	3	2	116.3
	500	12,000			1	13320	2	3	2	115.8	13758	2	3	2	119.6	14273	2	3	2	124.1
					2	12227	2	3	2	106.3	12629	2	3	3	109.8	13102	2	3	3	113.9
					3	12066	2	3	3	104.9	12463	2	3	3	108.4	12930	2	3	3	112.4
					4W	11908	2	3	3	103.5	12300	2	3	3	107.0	12761	2	3	3	111.0
					1-HS	7890	1	3	2	68.6	8149	1	3	2	70.9	8454	1	3	2	73.5
					2-HS	6284	1	3	1	54.6	6491	1	3	1	56.4	6734	1	3	1	58.6
					3-HS	6174	1	3	2	53.7	6377	1	3	2	55.5	6616	1	3	2	57.5
					4W-HS	5647	1	3	2	49.1	5833	1	3	2	50.7	6052	1	3	2	52.6
					5Q	12799	3	3	2	111.3	13220	3	3	2	115.0	13715	3	3	2	119.3
					5W	11655	4	3	3	101.4	12039	4	3	3	104.7	12490	4	3	3	108.6
	700	16,000			1	17334	2	3	3	108.6	17904	2	3	3	112.2	18575	2	3	3	116.4
					2	15911	3	3	3	99.7	16434	3	3	3	103.0	17050	3	3	3	106.8
3			15702		2	3	3	98.4	16219	2	3	3	101.6	16826	3	3	3	105.8		
4W			15497		2	3	4	97.1	16006	2	3	4	100.3	16606	2	3	4	104.0		
1-HS			10267		1	3	2	64.3	10605	1	3	2	66.4	11002	1	3	2	68.9		
2-HS			8178		1	3	2	51.2	8447	1	3	2	52.9	8763	1	3	2	54.9		
3-HS			8034		1	3	2	50.3	8299	1	3	2	52.0	8609	1	3	2	53.9		
4W-HS			7349		1	3	2	46.0	7591	1	3	2	47.6	7875	1	3	2	49.3		
5Q			16656		3	3	2	104.4	17204	4	3	3	107.8	17848	4	3	3	111.8		
5W			15168		4	3	3	95.0	15667	4	3	3	98.2	16254	4	3	3	101.8		

**DELIVERED LUMENS**

**LUMINAIRE PERFORMANCE – FLAT GLASS LENS**

LED #	Drive Current	Lumen Package	Lens	Distribution	3000K 70CRI				4000K 70CRI				5000K 70CRI						
					Lumen	Bug Rating		Efficacy (Lm/W)	Lumen	Bug Rating		Efficacy (Lm/W)	Lumen	Bug Rating		Efficacy (Lm/W)			
72	225	Microcore Equivalent	Flat Glass Lens	1	5768	1	0	1	115.4	5957	1	0	1	119.1	6182	1	0	1	123.6
				2	5293	1	0	1	105.9	5468	1	0	1	109.4	5673	1	0	1	113.5
				3	5220	1	0	2	104.4	5392	1	0	2	107.8	5593	1	0	2	111.9
				4W	5149	1	0	2	103.0	5318	1	0	2	106.4	5517	1	0	2	110.3
				1-HS	3416	0	0	1	68.3	3529	0	0	1	70.6	3660	0	0	1	73.2
				2-HS	2723	0	0	1	54.5	2812	0	0	1	56.2	2917	0	0	1	58.3
				3-HS	2674	0	0	1	53.5	2761	0	0	1	55.2	2865	0	0	1	57.3
				4W-HS	2445	0	0	1	48.9	2526	0	0	1	50.5	2620	0	0	1	52.4
				5Q	5538	2	0	1	110.8	5720	2	0	1	114.4	5934	2	0	1	118.7
				5W	5041	3	0	1	100.8	5207	3	0	1	104.1	5402	3	0	1	108.0
				1	8203	1	0	1	108.7	8472	1	0	1	112.3	8790	1	0	2	116.5
				2	7527	2	0	2	99.7	7775	2	0	2	103.0	8067	2	0	2	106.9
				3	7674	1	0	2	101.7	7928	1	0	2	105.1	8224	1	0	2	109.0
				4W	7322	1	0	3	97.0	7563	1	0	3	100.2	7846	1	0	3	104.0
				1-HS	4858	1	0	1	64.4	5018	1	0	1	66.5	5206	1	0	1	69.0
				2-HS	3872	0	0	1	51.3	3999	1	0	1	53.0	4149	1	0	1	55.0
				3-HS	3802	1	0	2	50.4	3927	1	0	1	52.0	4075	1	0	1	54.0
				4W-HS	3478	1	0	1	46.1	3592	1	0	1	47.6	3727	1	0	1	49.4
	5Q	7876	3	0	1	104.4	8135	3	0	1	107.8	8439	3	0	1	111.8			
	5W	7169	3	0	2	95.0	7405	3	0	2	98.1	7683	3	0	2	101.8			
	1	8378	1	0	1	107.7	8654	1	0	1	111.2	8978	1	0	2	115.4			
	2	7689	2	0	2	98.8	7942	2	0	2	102.1	8239	2	0	2	105.9			
	3	7582	1	0	2	97.5	7831	1	0	2	100.7	8125	2	0	2	104.4			
	4W	7478	1	0	3	96.1	7725	1	0	3	99.3	8014	1	0	3	103.0			
	1-HS	4962	1	0	1	63.8	5125	1	0	1	65.9	5318	1	0	1	68.4			
	2-HS	3955	1	0	1	50.8	4085	1	0	1	52.5	4238	1	0	1	54.5			
	3-HS	3883	1	0	1	49.9	4011	1	0	1	51.6	4162	1	0	1	53.5			
	4W-HS	3552	1	0	1	45.7	3669	1	0	1	47.2	3806	1	0	1	48.9			
	5Q	8044	3	0	1	103.4	8309	3	0	1	106.8	8620	3	0	1	110.8			
	5W	7323	3	0	2	94.1	7564	3	0	2	97.2	7847	3	0	2	100.9			
	1	11566	1	0	2	100.6	11947	1	0	2	103.9	12394	1	0	2	107.8			
	2	10615	2	0	2	92.3	10963	2	0	2	95.3	11374	2	0	2	98.9			
	3	10822	2	0	2	94.1	11177	2	0	2	97.2	11596	2	0	2	100.8			
	4W	10324	2	0	3	89.8	10664	2	0	3	92.7	11063	2	0	3	96.2			
	1-HS	6850	1	0	1	59.6	7076	1	0	1	61.5	7340	1	0	1	63.8			
	2-HS	5459	1	0	1	47.5	5639	1	0	1	49.0	5850	1	0	1	50.9			
	3-HS	5361	1	0	1	46.6	5538	1	0	1	48.2	5745	1	0	1	50.0			
	4W-HS	4903	1	0	1	42.6	5065	1	0	1	44.0	5254	1	0	1	45.7			
	5Q	11105	3	0	2	96.6	11470	3	0	2	99.7	11899	3	0	2	103.5			
	5W	10109	3	0	2	87.9	10441	3	0	2	90.8	10832	4	0	2	94.2			
	1	15052	2	0	2	94.3	15547	2	0	2	97.4	16128	2	0	2	101.1			
	2	13812	2	0	2	86.5	14267	2	0	2	89.4	14801	3	0	3	92.7			
3	14083	2	0	2	88.2	14545	2	0	2	91.1	15090	2	0	2	94.3				
4W	13435	2	0	3	84.2	13877	2	0	3	86.9	14397	2	0	4	90.2				
1-HS	8915	1	0	1	55.9	9208	1	0	1	57.7	9553	1	0	1	59.9				
2-HS	7105	1	0	1	44.5	7339	1	0	1	46.0	7614	1	0	1	47.7				
3-HS	6977	1	0	2	43.7	7207	1	0	1	45.2	7476	1	0	2	46.8				
4W-HS	6380	1	0	2	40.0	6591	1	0	2	41.3	6837	1	0	2	42.8				
5Q	14451	3	0	2	90.5	14926	3	0	2	93.5	15485	3	0	2	97.0				
5W	13155	4	0	3	82.4	13588	4	0	3	85.1	14097	4	0	3	88.3				

**DELIVERED LUMENS**

**LUMINAIRE PERFORMANCE – DIFFUSED DROP LENS**

LED #	Drive Current	Lumen Package	Lens	Distribution	3000K 70CRI				4000K 70CRI				5000K 70CRI						
					Lumen	Bug Rating			Efficacy (Lm/W)	Lumen	Bug Rating			Efficacy (Lm/W)	Lumen	Bug Rating			Efficacy (Lm/W)
72	225	Microcore Equivalent	Diffused Drop Lens	3	5186	1	3	3	103.7	5357	1	3	3	107.1	5558	1	3	3	111.2
				5W	5010	2	3	2	100.2	5175	2	3	2	103.5	5368	2	3	3	107.4
	335	8,500		3	7376	2	3	3	97.7	7618	2	3	3	100.9	7904	2	3	3	104.7
				5W	7125	3	3	3	94.4	7359	3	3	3	97.5	7635	3	3	3	101.1
	345	Microcore Equivalent		3	7533	2	3	3	96.8	7781	2	3	3	100.0	8073	2	3	3	103.8
				5W	7277	3	3	3	93.5	7516	3	3	3	96.6	7798	3	3	3	100.2
	500	12,000		3	10400	2	4	4	90.4	10742	2	4	4	93.4	11144	2	4	4	96.9
				5W	10046	3	3	3	87.4	10376	3	4	3	90.2	10765	3	4	3	93.6
	700	16,000		3	13637	3	4	5	85.4	14085	3	4	5	88.2	14613	3	4	5	91.5
				5W	12973	3	4	4	81.3	13400	3	4	4	83.9	13902	3	4	4	87.1

**PHOTOMETRY**

**PRMD2-72L-700-4K7-1**

**LUMINAIRE DATA**

Description	<b>4000 Kelvin, 70CRI</b>
Delivered Lumens	<b>17904</b>
Watts	<b>159.6</b>
Efficacy	<b>112.2</b>
IES Type	<b>I</b>
BUG Rating	<b>B2-U3-G3</b>
Mounting Height	<b>30 ft</b>
Grid Scale	<b>30 ft</b>

**ZONAL LUMEN SUMMARY**

Zone	Lumens	% Luminaire
Downward Street Side	14466	81%
Downward House Side	2829	16%
Downward Total	17295	97%
Upward Street Side	180	1%
Upward House Side	429	2%
Upward Total	609	3%
Total Flux	17904	100%

**ISOFOOT CANDLE PLOT**

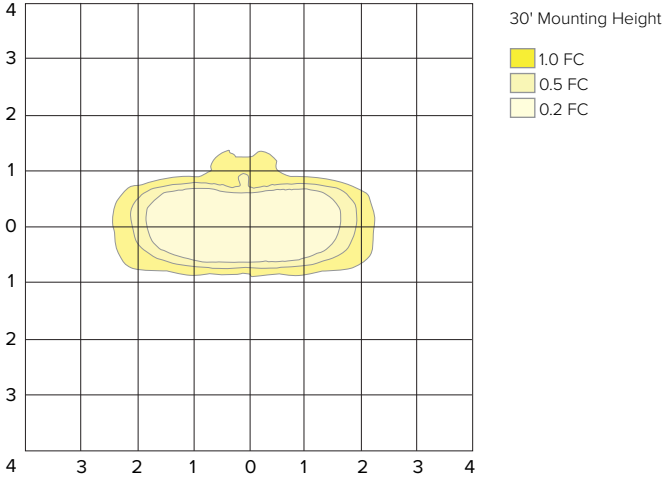

**PRMD2-72L-700-4K7-3**

**LUMINAIRE DATA**

Description	<b>4000 Kelvin, 70CRI</b>
Delivered Lumens	<b>16219</b>
Watts	<b>159.6</b>
Efficacy	<b>101.6</b>
IES Type	<b>III</b>
BUG Rating	<b>B2-U3-G3</b>
Mounting Height	<b>30 ft</b>
Grid Scale	<b>30 ft</b>

**ZONAL LUMEN SUMMARY**

Zone	Lumens	% Luminaire
Downward Street Side	12576	77%
Downward House Side	3313	20%
Downward Total	15889	97%
Upward Street Side	180	1%
Upward House Side	365	2%
Upward Total	545	3%
Total Flux	16434	100%

**ISOFOOT CANDLE PLOT**

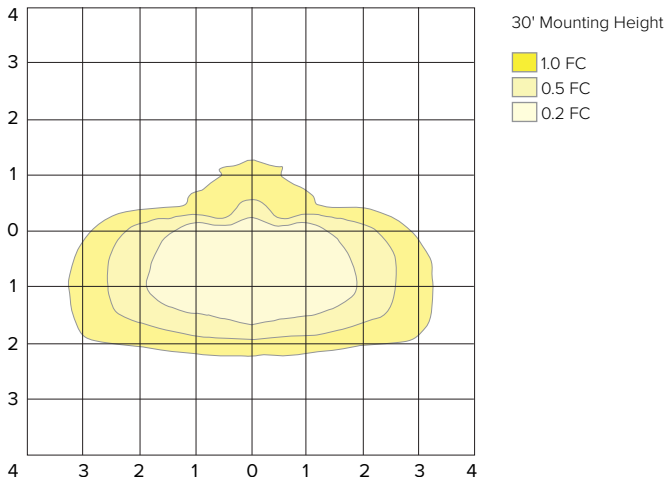

**PRMD2-72L-700-4K7-5Q**

**LUMINAIRE DATA**

Description	<b>4000 Kelvin, 70CRI</b>
Delivered Lumens	<b>17204</b>
Watts	<b>159.6</b>
Efficacy	<b>107.8</b>
IES Type	<b>VS</b>
BUG Rating	<b>B4-U3-G3</b>
Mounting Height	<b>30 ft</b>
Grid Scale	<b>30 ft</b>

**ZONAL LUMEN SUMMARY**

Zone	Lumens	% Luminaire
Downward Street Side	12769	79%
Downward House Side	2912	18%
Downward Total	15681	97%
Upward Street Side	161	1%
Upward House Side	377	2%
Upward Total	538	3%
Total Flux	16219	100%

**ISOFOOT CANDLE PLOT**

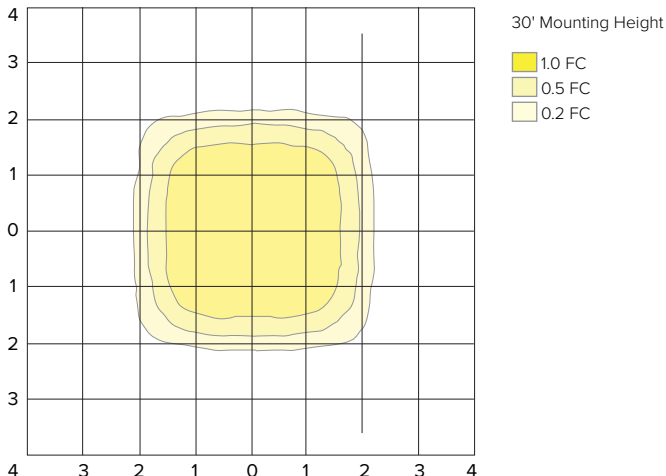

**PHOTOMETRY**

**PRMD2-72L-700-4K7-2**

**LUMINAIRE DATA**

Description	4000 Kelvin, 70CRI
Delivered Lumens	15979
Watts	159.1
Efficacy	100.4
IES Type	II
BUG Rating	B3-U4-G3
Mounting Height	30 ft
Grid Scale	30 ft

**ZONAL LUMEN SUMMARY**

Zone	Lumens	% Luminaire
Downward Street Side	13182	82%
Downward House Side	2292	14%
Downward Total	15474	97%
Upward Street Side	141	1%
Upward House Side	391	2%
Upward Total	532	3%
Total Flux	16006	100%

**ISOFOOT CANDLE PLOT**

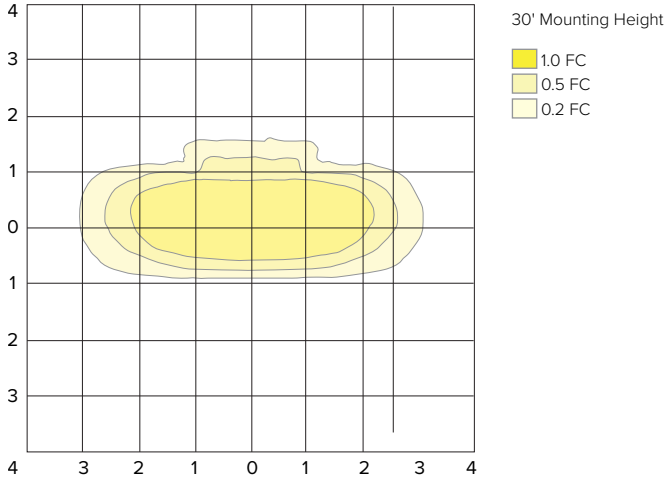

**PRMD2-72L-700-4K7-4**

**LUMINAIRE DATA**

Description	4000 Kelvin, 70CRI
Delivered Lumens	15625
Watts	159.1
Efficacy	98.2
IES Type	IV
BUG Rating	B3-U3-G3
Mounting Height	30 ft
Grid Scale	30 ft

**ZONAL LUMEN SUMMARY**

Zone	Lumens	% Luminaire
Downward Street Side	8309	48.3%
Downward House Side	8309	48.3%
Downward Total	16618	96.6%
Upward Street Side	293	1.7%
Upward House Side	293	1.7%
Upward Total	586	3.4%
Total Flux	17204	100%

**ISOFOOT CANDLE PLOT**

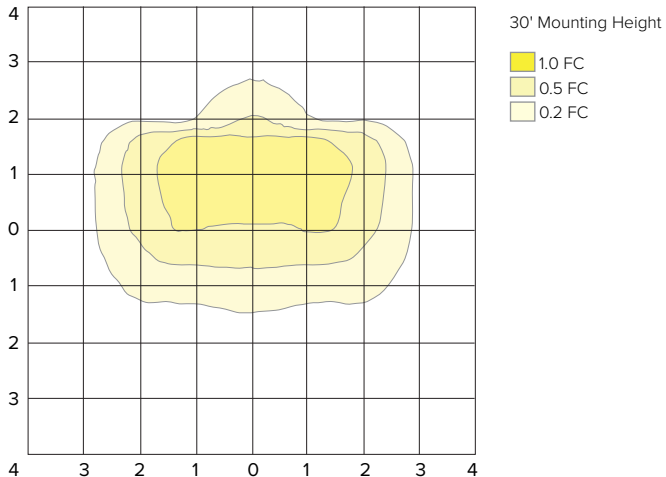

**PRMD2-72L-700-4K7-5W**

**LUMINAIRE DATA**

Description	4000 Kelvin, 70CRI
Delivered Lumens	15365
Watts	159.1
Efficacy	97
IES Type	VS
BUG Rating	B4-U3-G2
Mounting Height	30 ft
Grid Scale	30 ft

**ZONAL LUMEN SUMMARY**

Zone	Lumens	% Luminaire
Downward Street Side	7573	48.3%
Downward House Side	7573	48.3%
Downward Total	15146	96.7%
Upward Street Side	260	1.7%
Upward House Side	260	1.7%
Upward Total	520	3.3%
Total Flux	15667	100%

**ISOFOOT CANDLE PLOT**

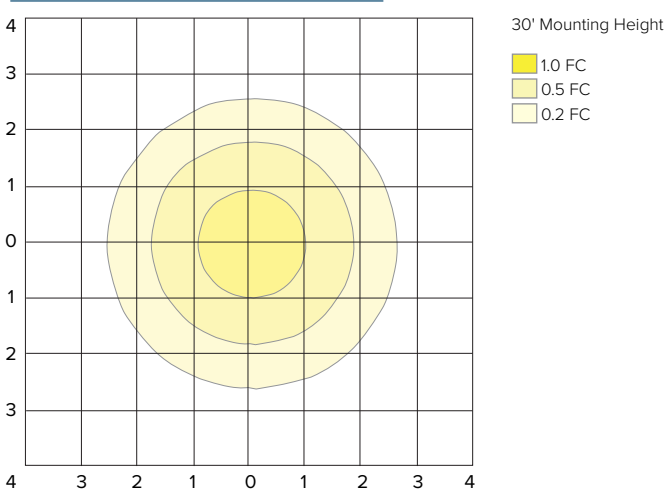

**TM-30 DATA**

**COLOR VECTOR GRAPHIC**

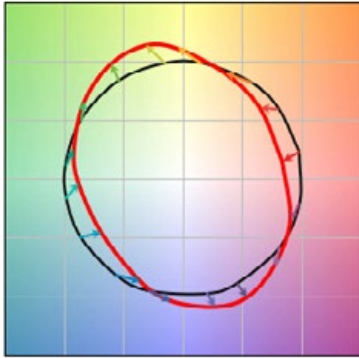

— Reference Illuminant — Test Source

**TEST SOURCE**

MBM TEST RESULTS	
CCT (K)	3947
CIE Ra	72
Duv	0.0004
x	0.3831
y	0.3793
Rf	68
Rg	99

**ELECTRICAL DATA**

Light Engine	System Watts	System Current	Electrical							Dimming					
			Line Voltage		Amps AC				Min. Power Factor	Max THD (%)	Dimming Range	Source current out of 0-10V		Absolute voltage range on 0-10V (+)	
			VAC	HZ	120	208	240	277				Min	Max	Min	Max
72L	50.0	225 mA	120-277	50/60	0.42	0.24	0.21	0.18	>0.9	20	10% to 100%	0mA	1mA	0V	10V
	75.5	335 mA			0.63	0.36	0.31	0.27							
	77.8	345 mA			0.65	0.37	0.32	0.28							
	115.0	500 mA			0.96	0.55	0.48	0.42							
	159.6	700 mA			1.33	0.77	0.67	0.58							

AMBER MULTIPLIER	
CCT	MULTIPLIER
5000K	1
AM	0.1727

2700K MULTIPLIER	
CCT	MULTIPLIER
5000K	1
2700K	0.897

LENS OPTION MULTIPLIER	
CLEAR LENS	DIFFUSED LENS
0.9032	0.8619