

AAL ARMS

SPECIFICATIONS

CONSTRUCTION

- The arm shall be of one piece unitized aluminum construction, fully welded and assembled. The back plate shall be one piece cast aluminum. The arm shall be prewired with a quick connector for easy installation.
- The arm shall have a cast aluminum fitter welded to the top of the arm(s) for attaching the fixture. The fixture shall be mounted with three stainless steel bolts through the top of the arm fitter into the fixture. The attachment point shall have a silicone pad for sealing the fixture to arm connection.
- Mounting hardware and J-box by others.



ORDERING GUIDE

Example: WMA7-BLT

CATALOG #

HOUSING

Arm	Color
WMA7 Weight: 16 lbs.	BLS Black Gloss Smooth
	BLT Black Matte Textured
	DBS Dark Bronze Gloss Smooth
	DBT Dark Bronze Matte Textured
	GTT Graphite Matte Textured
	LGS Light Grey Gloss Smooth
	LGT Light Grey Matte Textured
	PSS Platinum Silver Gloss Smooth
	VGT Verde Green Matte Textured
	WHS White Gloss Smooth
	WHT White Matte Textured
	Color Option
CC ¹ Custom Color	

Notes:

- 1 Consult factory for custom color, marine and corrosive finish

DIMENSIONS

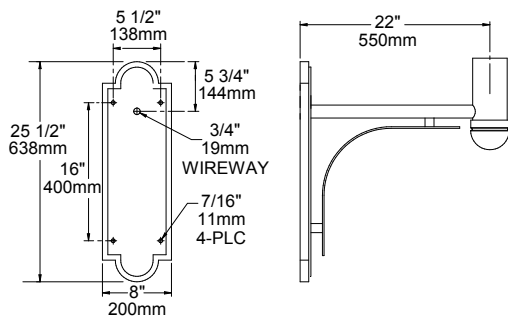

WMA7

Note: Back plate is welded to the arm.