

D2LED WW

2" LED WALL WASH
120/277V



APPLICATIONS:

Architektür D2LED WW is a 2" specification grade LED wall wash that combines superior brightness control with energy savings and low maintenance costs. Suitable for a variety of commercial, retail, and institutional applications with ambient temperatures up to 35°C (7L) or 25°C (9L, 12L) during operation with free airflow around the fixture.

J-TUBE ASSEMBLY:

Utilizing Prescolite's revolutionary J-Tube design and optimal thermal management, the D2LED eliminates the need for a traditional downlight housing. The J-Tube assembly combines the traditional J-Box and driver electronics into a compact form that can be installed and accessed from below the ceiling plane.

REFLECTOR:

High purity spun aluminum self-flanged reflector with iridescence suppressed Alzak anodized finishes. Also available with Prescolite's American Matte™ (MFC) or Kurt Versen finishes. Painted reflectors are also available. A novel Wall Wash optical system provides an unequalled wall wash optical distribution from the same small aperture. Available in standard wall wash or innovative shielded wall wash which eliminates side light and directs peripheral light toward the wall. Use standard wall wash for wall and room illumination. The shielded wall wash is ideal for corridors or other spaces with viewing angles perpendicular to the wall.

LED LIGHT ENGINE:

Xicato LED Module has a fixture to fixture color consistency of less than 2 SDCM. Secured to an extruded aluminum heat sink for excellent thermal management providing optimal life and lumen maintenance (minimum 50,000 hours at 70% lumen maintenance).

LED DRIVER:

Energy efficient electronic constant current driver with 50,000 hour minimum anticipated life. Meets UL Class 2, FCC 47CFR Part 15, Class B compliant, inherent short-circuit protection, self limited, overload protected.

DIMMING:

Comes standard with 0-10V dimming capability. Flicker-free dimming to 10%. For sizing control systems, the 0-10V control circuit will draw up to 1 mA. Also available with 0-10V to below 1% or Lutron Ecosystem to 1%.

CERTIFICATIONS:

CSA C/US certified to UL1598. Suitable for wet locations. Non-IC rated and 2IN/2OUT through branch wiring. For connection to flexible conduit only.

WARRANTY:

5 Year Warranty.

DATE: _____ TYPE: _____

FIRM NAME: _____

PROJECT: _____



Ceiling Cutout: 2 7/8"
Ceiling Thickness 1/2"-1 1/4"
Not to Scale

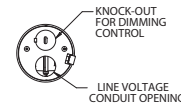
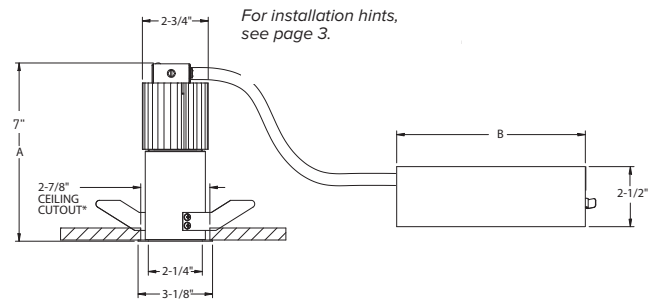

J-TUBE	
OPTIONS	DIM "B"
STANDARD	6-1/8"
EDM	6-1/8"
DM01	10"

CATALOG NUMBER:

EXAMPLE: D2LEDEM-2D9LED9L30K8SWW

Order accessories separately

J-TUBE ASSEMBLY	VOLTAGE	LIGHT ENGINE	OUTPUT	LED COLOR	CRI	BEAM ANGLE	REFLECTOR FINISH	REFLECTOR COLOR	FLANGE OPTIONS	ACCESSORIES
<input type="checkbox"/> D2LED J-Tube Assembly with Standard 0-10V 10% Dimming <input type="checkbox"/> EDM² Hi-Lume 1% EcoSystem LED Driver <input type="checkbox"/> DM01² eLdoED 0-10V dimming to less than 1%.	Standard 120/277V OPTIONS Standard 0-10V 10% Dimming <input type="checkbox"/> EDM² Hi-Lume 1% EcoSystem LED Driver <input type="checkbox"/> DM01² eLdoED 0-10V dimming to less than 1%.	<input type="checkbox"/> 2D9LED 2" Open Reflector/Light Engine Assembly with Xicato module <input type="checkbox"/> 7L 700 Delivered Lumens <input type="checkbox"/> 9L 900 Delivered Lumens <input type="checkbox"/> 12L 1200 Delivered Lumens	<input type="checkbox"/> 27K 2700 Kelvin <input type="checkbox"/> 30K 3000 Kelvin <input type="checkbox"/> 35K 3500 Kelvin <input type="checkbox"/> 40K 4000 Kelvin	<input type="checkbox"/> 8 Nominal 80+ CRI <input type="checkbox"/> 9¹ Nominal 95+ CRI	<input type="checkbox"/> WW Wall Wash <input type="checkbox"/> SWW Shielded Wall Wash	<input type="checkbox"/> Standard Specular <input type="checkbox"/> SS Semi-Specular <input type="checkbox"/> MFC American Matte™ <input type="checkbox"/> VS Kurt Versen Softglow® <input type="checkbox"/> VSS Kurt Versen SoftSheen™	<input type="checkbox"/> Standard Clear Alzak <input type="checkbox"/> CG Champagne Gold Alzak <input type="checkbox"/> BL Black Alzak <input type="checkbox"/> LW Light Wheat Alzak <input type="checkbox"/> PW Pewter Alzak <input type="checkbox"/> BC Painted Flat Black Cone <input type="checkbox"/> WC Painted White Cone	<input type="checkbox"/> Standard Anodized <input type="checkbox"/> WT White Trim Flange <input type="checkbox"/> BT Flat Black Trim Flange	<input type="checkbox"/> FMR2 2" Flush Mount Ring <input type="checkbox"/> D2FRM Mounting Frame <input type="checkbox"/> D2ICAT² IC Rated, Air Tight housing <input type="checkbox"/> D2CP² CCEA compliant housing <input type="checkbox"/> LiteGear³ Inverter, single phase central lighting, 125VA-250VA <input type="checkbox"/> LPS Series³ LitePower micro-inverter, 20VA-55VA	
										1 95+ CRI not available on 12L
										2 EDM, DM01, and 12L models are not compatible with D2ICAT or D2CP. See additional notes on page 4 for important product life/warranty information when using D2ICAT or D2CP with 9L 95 CRI 3 See Central Inverter compatibility note and web links on page 3

D2LED WW

2" LED WALL WASH
120/277V

ELECTRICAL DATA	7L		9L		12L
	80+ CRI	95 CRI	80+ CRI	95 CRI	80+ CRI
Input Voltage	120 or 277V	120 or 277V	120 or 277V	120 or 277V	120 or 277V
Input Frequency	50/60 Hz	50/60 Hz	50/60 Hz	50/60 Hz	50/60 Hz
Input Power (Watts)	12.6 W	19.0 W	17.2 W	23.4 W	21.1 W
Input Current (@120V)	0.106 A	0.160 A	0.146 A	0.190 A	0.180 A
Input Current (@277V)	0.046 A	0.069 A	0.063 A	0.085 A	0.077 A
Constant Current Output	610 mA	560 mA	560 mA	700 mA	700 mA
Power Factor	≥0.90	≥0.90	≥0.90	≥0.90	≥0.90
EMI Filtering (FCC CFR, Part 15)	Class B	Class B	Class B	Class B	Class B
Operating Temp	-30°C to 35°C	-30°C to 35°C	-30°C to 25°C	-30°C to 25°C	-30°C to 25°C

Lumen Multipliers For Various Alzak Colors

Clear Specular	1.00
Pewter Specular	0.94
Champagne Gold Specular	0.96
Light Wheat Specular	0.84
Black Specular	0.62

Note: These values are based upon the WFL45 Reflectors.

*Data for standard 0-10V 10% dimming models. Electrical and photometric data may vary slightly with other dimming options.
**Short circuit, over-voltage, over-current protection.

PERFORMANCE SUMMARY

Model	Output	Beam Distribution	Delivered Lumens	Input Watts	Lumens Per Watt	Full Catalog Number
D2LED	7L	WW	705	12.6	56	D2LED-2D9LED7L30K8WW
		SWW	389	12.6	30.9	D2LED-2D9LED7L30K8SWW
	9L	WW	900	17.2	52.3	D2LED-2D9LED9L30K8WW
		SWW	497	17.2	28.9	D2LED-2D9LED9L30K8SWW
	12L	WW	1079	21.1	51.1	D2LED-2D9LED12L30K8WW
		SWW	596	21.1	28.2	D2LED-2D9LED12L30K8SWW

D2LED-2D9LED12L30K8WW

LED Light Engine: 3000K, 80 CRI
System Wattage: 21.1W
Fixture Delivered Lumens: 1079
Fixture Efficacy: 51.1

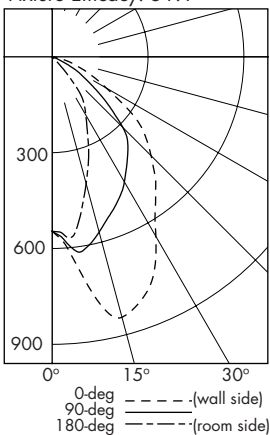

CANDELA DISTRIBUTION

DEG	0	90	180
0	546	546	546
5	611	591	568
15	844	568	411
25	751	492	261
35	564	408	170
45	438	313	5
55	296	144	0
65	133	36	0
75	46	0	0
85	0	0	0
90	0	0	0

LUMINANCE DATA IN CANDELA/SQ. METER

Angle in Vertical	0 DEG	90 DEG	180 DEG
45°	216723	154873	2474
55°	180558	87839	0
65°	110108	29804	0
75°	62184	0	0
85°	0	0	0



**2.5' DISTANCE FIXTURE MOUNTED OUT FROM WALLS
FOOTCANDLE DISTRIBUTION ON WALL SURFACE (Direct Only)**

DISTANCE FROM CEILING IN FEET	FOOTCANDLE DISTRIBUTION ON WALL SURFACE (Direct Only)													
	1	2	3	4	5	6	7	8	9	10	11	12		
1	18	14	7	3	1				21	21	23	20	13	20
2	24	20	12	6	3				31	34	35	27	24	30
3	18	16	11	7	4				26	30	31	22	23	25
4	13	11	8	6	4				20	23	24	17	18	20
5	9	8	6	5	3				15	17	18	13	14	16
6	7	6	5	4	3				12	13	14	10	11	12
7	5	5	4	3	2				9	10	11	8	9	9
8	4	4	3	3	2				8	8	9	7	7	8
9	3	3	3	2	2				6	7	7	6	6	7

D2LED-2D9LED12L30K8WW

Test No. 17.02643

Test No. 17.02643

Tested at 25°C Ambient in accordance to IESNA LM-79-2008

D2LED WW

2" LED WALL WASH
120/277V

D2LED-2D9LED1 2L30K85WW
LED Light Engine: 3000K, 80 CRI
System Wattage: 21.1W
Fixture Delivered Lumens: 596
Fixture Efficacy: 28.2

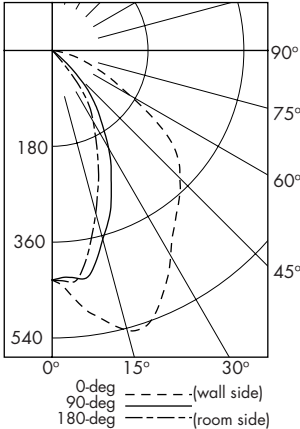

CANDELA DISTRIBUTION

DEG	0	90	180
0	431	431	431
5	467	428	437
15	544	367	316
25	497	262	198
35	401	159	113
45	339	68	1
55	247	6	0
65	117	1	0
75	45	0	0
85	0	0	0
90	0	0	0

LUMINANCE DATA IN CANDELA/SQ. METER

Angle in Vertical	0 DEG	90 DEG	180 DEG
45°	167737	33646	495
55°	150668	3660	0
65°	96862	828	0
75°	60832	0	0
85°	0	0	0



**2.5' DISTANCE FIXTURE MOUNTED OUT FROM WALLS
FOOTCANDLE DISTRIBUTION ON WALL SURFACE (Direct Only)**

DISTANCE FROM CEILING IN FEET	1	2	3	4	5	6	7	8	9	12	14	16	18	20	22	24	26	28	30			
1	12	8	3	1	0	14	12	14	13	7	13	19	14	7	3	1	22	22	24	20	14	21
2	14	11	7	4	2	18	20	21	16	14	17	9	8	5	3	2	12	15	16	11	11	13
3	7	6	4	3	2	10	11	12	9	9	10	5	4	3	2	2	7	9	9	7	7	8
4	3	3	3	2	1	6	7	7	5	6	6	3	3	3	2	1	5	5	6	4	5	5
5	3	2	2	2	1	5	5	6	4	5	5	2	2	2	2	1	4	5	5	4	4	4
6	2	2	2	1	1	4	5	5	4	4	4											

D2LED-2D9LED1 2L30K85WW

Test No. 17.02645

Test No. 17.02645

Tested at 25°C Ambient in accordance to IESNA LM-79-2008

CENTRAL INVERTERS

For full fixture output in back-up mode, we recommend you visit currentlighting.com/dual-lite for your Central Lighting Inverter options.

Please contact your local Current representative for any assistance with proper sizing and loading of your inverter selection.

Central lighting inverters must be ordered separately.

INSTALLATION HINTS

Daisy Chain:

Often times through branch wiring (Daisy Chaining) will be desired for installation of the D2LED in an application. There is one knock out available in the J-tube for the line voltage, and one for the low voltage control wires. To accomplish 2in/2out through branch wiring. Prescolite suggests the use of an Arlington Duplex Connector (PN 4040AST).

Ceiling Cut-out:

Due to the discrete trim flange on the D2LED, the accuracy of the 2-7/8" ceiling cut-out is critical to achieving the best results. Prescolite recommends making this cut-out with a 2-7/8" hole saw, such as one manufactured by the Morse Company (TAC46 and TACPD4).

Ceiling Clearance:

When no top access is available to the J-Tube, 6-3/4" of plenum clearance is recommended for the standard and EDM driver/J-Tube options. For DM01 option, 10-1/2" plenum clearance is recommended.

ADDITIONAL NOTES

*Note: Use of the D2ICAT and D2CP can cause heat entrapment, which while safe to use, can shorten the expected life of this product from > 50,000 hours to 25,000 hours when used with the 9L or 95 CRI options. The product warranty in these applications will be 5 years, or 25,000 hours, which ever comes first.

*Note: Ceiling thickness maximum when using D2ICAT or D2CP is 5/8". Ceiling thickness maximum when using D2FRM is 1". Bar hangers not included, order B6 for ceiling joists up to 24" centers or B24 for T-bar ceilings.

*Note: The standard product is designed and listed to be installed into most ceiling types without the use of an accessory frame. These frames are provided as an optional accessory to be used when desired by the end user to provide extra support or required by local code.

*Note: CP versions require the use of the D2ICAT accessory modified with metal plate in place of polycarbonate.

D2LED WW

2" LED WALL WASH
120/277V

ACCESSORIES

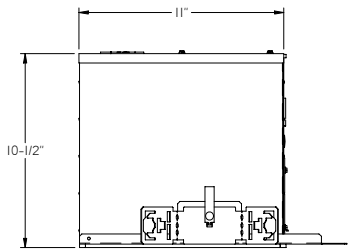
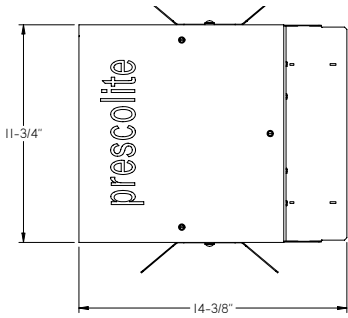

D2ICAT/D2CP

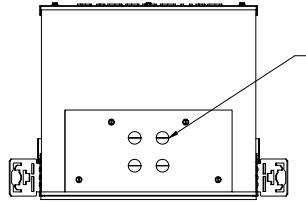

Entry Points
For 3/8" Max.
MC Flex.
See instruction sheet
for installation details.
www.prescolite.com

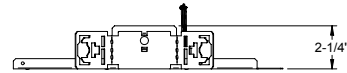
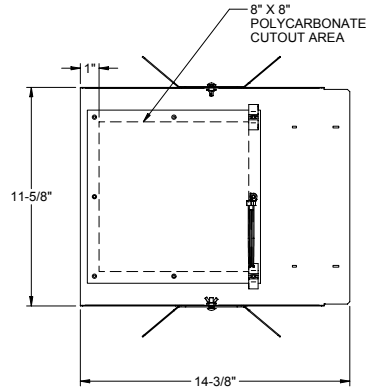

D2FRM

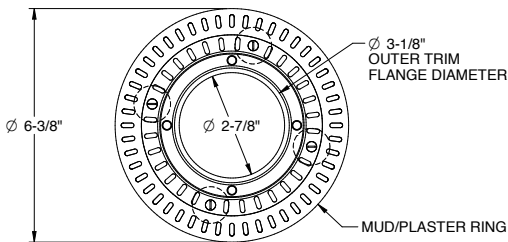
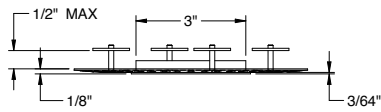
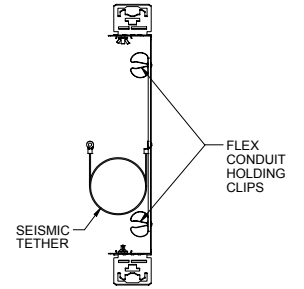

FMR2