

AA-10 Cobra

ARMS

DATE: _____ LOCATION: _____

TYPE: _____ PROJECT: _____

CATALOG #: _____

SPECIFICATIONS

CONSTRUCTION

- All cast aluminum parts shall be low copper alloy A356. All extruded aluminum parts shall be alloy 6061-T6, 6063-T5 or equal
- ALL Beacon Decorative Arms mount to an Open Top Pole.

EPA (EFFECTIVE PROJECTED AREA)

- EPA is defined as (projected surface area X drag factor) and measured in ft². Allowable post, luminaire arm, luminaire and accessory EPAs are derived from the most current published AASHTO (American Association of State Highway and Transportation Officials) standard, currently AASHTO 2001 (50yr design life). Customer assumes all responsibility for selecting the appropriate post for installation (consult factory for assistance). Luminaire arm, luminaire and accessory EPA must be equal to or less than allowable EPA of post. Consult a professional engineer for compliance with local codes and standards

FASTENERS

- All fasteners shall be Corrosion Resistant. When tamper resistant fasteners are required, spanner HD (snake eye) style shall be provided (special tool required, available at additional cost)

FINISH

- Finish shall be a Beacote V polyester powder-coat electro-statically applied and thermocured. Beacote V finish shall consist of a five stage iron phosphate chemical pretreatment regimen with a polymer primer sealer, oven dry off, and top coated with a thermoset super TGIC polyester powder coat finish. The finish shall meet the AAMA 605.2 performance specification which includes passing a 3000 hour salt spray test for corrosion resistance and resists cracking or loss of adhesion per ASTM D522 and resists surface impacts of up to 160 inch-pound

WARRANTY

- 5 year warranty



ORDERING GUIDE

Example: AA-10-S-5-B-S-BBT

CATALOG # AA-10-

Model	Post Shaft Profile	Post Shaft Diameter	Arrangement	Luminaire Mounting	Color
AA-10 Cobra Arm	W Wall Mount S Smooth F Fluted	4 4" 5 5" 6 6"	See arrangement table below	S Side Mount	BLT Black Matte Textured BLS Black Gloss Smooth DBT Dark Bronze Matte Textured DBS Dark Bronze Gloss Smooth GTT Graphite Matte Textured LGS Light Grey Gloss Smooth LGT Light Grey Matte Textured PSS Platinum Silver Smooth WHT White Matte Textured WHS White Gloss Smooth VGT Verde Green Textured Color Option CC Custom Color

EPA INDEX INFORMATION

		arrangement (EPA index ft ² / weight (lbs))		
				
shaft Ø		A	B	C
wall	weight	7	-	-
	EPA	0.90	1.37	2.17
Ø4"	weight	-	10	15
	EPA	-	1.51	2.31
Ø5"	weight	-	12	17
	EPA	-	1.63	2.43
Ø6"	weight	-	17	18
	EPA	-	-	-

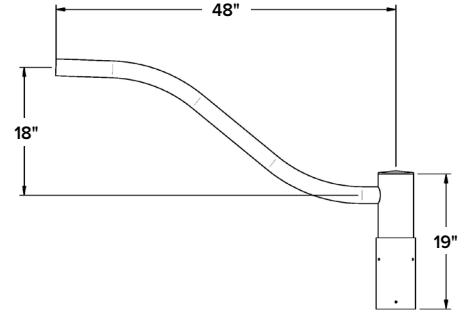

Cobra Arm

AA-10 Cobra

ARMS

DATE: _____ LOCATION: _____

TYPE: _____ PROJECT: _____

CATALOG #: _____

DIMENSIONS

ALL Beacon Decorative Arms mount to an Open Top Pole.

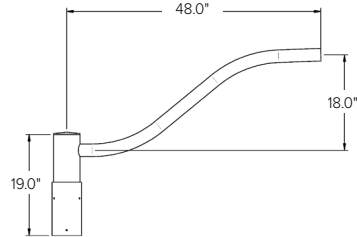
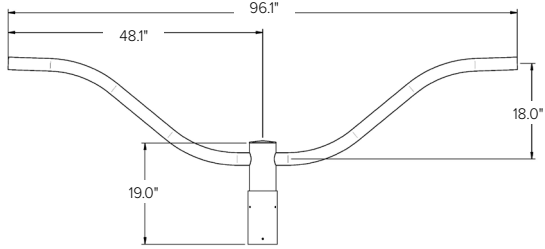

WALL BRACKET DETAILS

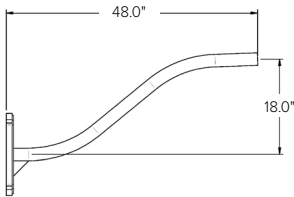

WALL PLATE DETAILS

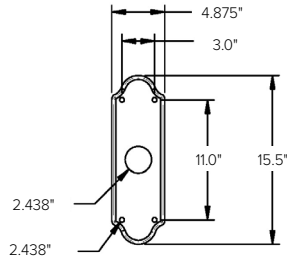

Due to our continued efforts to improve our products, product specifications are subject to change without notice.