

HSAS

ERA® STEPPED ALUMINUM SMOOTH POLE

Type:
Job:
Catalog number:

Approvals:

Pole Cat. No.	Mounting	Arm Drilling Option	Pole Finish	Optional Base Cove	Optional Pole Top Cap/Finial	Optional Duplex Receptical
_____	_____	_____	_____	_____	_____	_____
See page 2			See page 3	See page 4		

Specifications

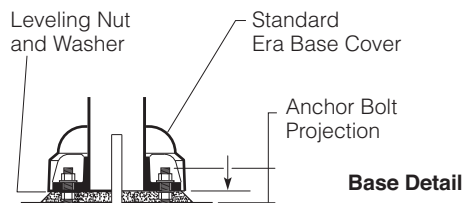
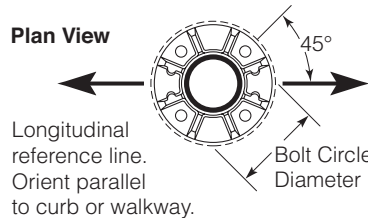
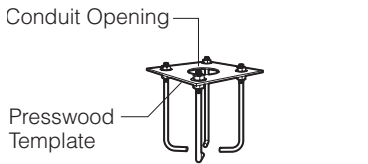

Grout **must** be packed under pole base to insure full contact with footing and prevent loosening of leveling nuts.

Concrete footing to be designed (by others). Provide a channel through the grout for drainage from the pole interior.

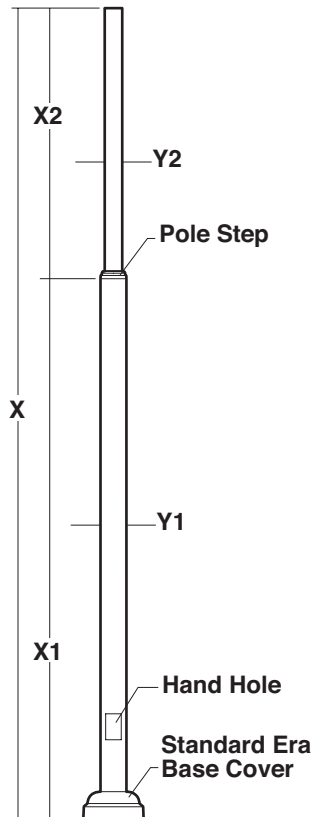

Pole Construction: Seamless round extruded aluminum tube of alloy 6061-T6, welded to top and bottom of aluminum base casting of alloy 356.

Base Cover: Two-piece, cast aluminum full cover, secured by stainless set screws. The standard base cover is the Era Base Cover. Two optional base cover styles available. (See page 4)

- 1) **HBC1** - Decorative smooth sided cast aluminum base cover.
- 2) **HBC2** - Traditional fluted side cast aluminum base cover.

Pole Cap: Flat cast aluminum provided for all side-mounted luminaires. Optional traditional style finial available. (See page 4)

- 1) **HF1** - Dome style cast aluminum cap.
- 2) **HF2** - Traditional style cast aluminum finial.

Handhole: 18" above the base cover, with a gasketed cover and ground lug.

Anchor Bolts: Four galvanized anchor bolts provided complete with eight nuts, eight flat washers, and a presswood template.

Vibration Dampener: All poles 25' and above include an internally mounted, factory installed pendulum vibration dampener, with flush stainless steel socket head fasteners finished to match pole.

Strength: Poles designed to withstand wind loads as listed in chart (See page 5) when luminaires are mounted per fixture installation instructions. Refer to specific Era® Collection mounting arm for specific luminaire and arm EPA.

Finish: Super TGIC thermoset polyester powder coat paint applied over a titanated zirconium conversion coating.

CAUTION: Do not install poles without luminaires or strength guarantee is voided. Any unauthorized accessories secured to pole shall void strength guarantee.

Maintenance: A regularly scheduled maintenance program must be established to insure the protective paint coating is intact, corrosion or structural damage has not occurred, and anchor bolt nuts are tight. Failure to do so could lead to pole collapse and serious personal injury.

Certification: Certified UL 1598 in accordance with Article 410 of ANSI/NFPA 70, National Electrical Code.

HSAS

ERA® STEPPED ALUMINUM SMOOTH POLE

Standard Features

NOTE: All allowable pole and fixture EPAs (Effective Projected Area, which is Fixture Area x Drag Factor) are derived from the AASHTO standard (American Association of State Highway and Transportation Officials). Responsibility lies with the specifier for correct pole selection based on local codes and standards for the job location (See page 5).

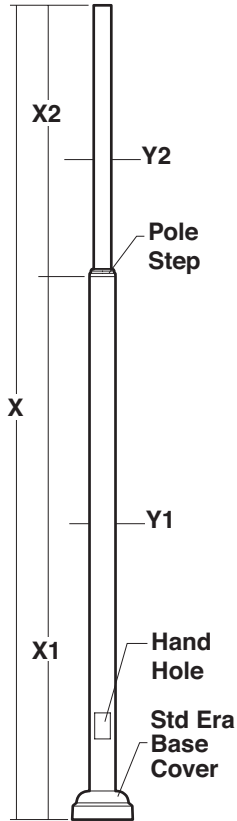

Pole Pole Catalog Number	Pole						Allowable Pole EPA					Wind Map Steady Wind		
	X	X1	X2	Y1	Y2		85	90	100	110	120	130	140	150
HSAS10-534188	10'	6.5'	3.5'	5"x.188	3.375"		29.54	26.14	23.92	19.55	16.24	13.67	11.63	9.99
HSAS12-534188	12'	8'	4'	5"x.188	3.375"		23.91	21.09	19.23	15.63	12.91	10.80	9.13	7.79
HSAS14-534188	14'	9.3'	4.7'	5"x.188	3.375"		19.80	17.38	15.79	12.74	10.45	8.67	7.26	6.14
HSAS16-534188	16'	10.5'	5.5'	5"x.188	3.375"		16.64	14.52	13.12	10.50	8.52	6.99	5.78	4.80
HSAS20-534188	19.5'	13'	6.4'	5"x.188	3.375"		11.73	10.09	9.02	7.06	5.60	4.47	3.58	2.87
HSAS14-64188	14'	9.3'	4.7'	6"x.188	4"		29.78	26.23	23.89	19.70	16.26	13.59	11.48	10.00
HSAS16-64188	16'	10.5'	5.5'	6"x.188	4"		25.24	22.12	20.08	16.54	13.56	11.25	9.42	8.29
HSAS20-64188	19.5'	13'	6.4'	6"x.188	4"		18.15	15.94	14.63	11.67	9.43	7.77	6.56	5.59
HSAS25-64188	25'	16.7'	8.3'	6"x.188	4"		11.85	10.21	9.34	7.19	5.56	4.40	3.62	3.00
HSAS25-64250	25'	16.7'	8.3'	6"x.250	4"		16.75	14.58	13.36	10.51	8.35	6.78	5.67	4.79
HSAS30-64250	30'	20'	10'	6"x.250	4"		11.63	9.96	9.10	6.90	5.25	4.08	3.31	2.71
HSAS30-64400 ¹	30'	20'	10'	6"x.400	4"		17.73	15.37	14.03	10.82	8.56	6.87	5.70	4.79

¹Pole reinforced, to 40" above base, to .400", remaining section is .250"

Anchor Base and Bolt Detail

Pole Height	Pole Diameter	Bolt Circle DIA	Anchor Bolt Projection	Anchor Bolts Size	Base Cover Size	Conduit Opening
10'-14'	5"	8 1/2"	3 1/4"	3/4" x 15" + 3"	11 7/8" DIA	3" DIA
16'-20'	5"	8 1/2"	3 1/4"	3/4" x 30" + 4"	11 7/8" DIA	3" DIA
14'	6"	10 1/2"	3 3/8"	3/4" x 15" + 3"	14" DIA	5" DIA
16'-30'	6"	10 1/2"	3 3/8"	3/4" x 30" + 4"	14" DIA	5" DIA

Mounting

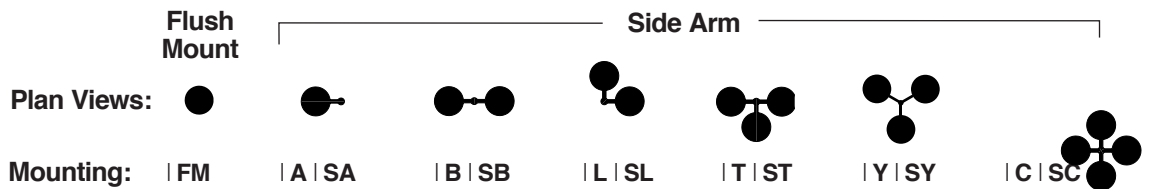

NOTE: Allowable Pole EPA for jobsite wind conditions must be equal to or greater than fixture mount EPA. Please refer to Kim luminaire catalog for specific fixture.

Available Arm Drilling

Please see pole drilling requirements in specific Kim luminaire catalog.

HA02S	HA02L	HA14S	HA14L	HA34S	HA34L	HA38S	HA38L
HA11S	HA11L	HA31S	HA31L	HA35S	HA35L	NO OPTION	
HA12S	HA12L	HA32S	HA32L	HA36S	HA36L		
HA13S	HA13L	HA33S	HA33L	HS37S	HA37L		

¹HA01S mounts to pole top O.D. of 3 3/8" | ²HA03S mounts to pole top O.D. of 3 3/8"

¹HA01L mounts to pole top O.D. of 4" | ²HA03L mounts to pole top O.D. of 4"

²Pole will be shipped with internal pole adaptor installed.

Standard Features

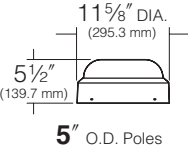
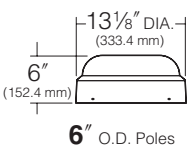
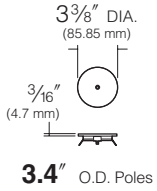
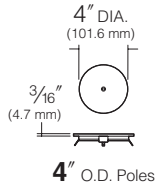
<p>Finish TGIC powder coat paint over a titanated zirconium conversion coating.</p>	<p>Cat. No.: Color:</p> <table border="0"> <tr> <td> BLS</td> <td>Black Gloss Smooth</td> <td> LGT</td> <td>Light Grey Matte Textured</td> </tr> <tr> <td> BLT</td> <td>Black Matte Textured</td> <td> PSS</td> <td>Platinum Silver Gloss Smooth</td> </tr> <tr> <td> DBS</td> <td>Dark Bronze Gloss Smooth</td> <td> VGT</td> <td>Verde Green Matte Textured</td> </tr> <tr> <td> DBT</td> <td>Dark Bronze Matte Textured</td> <td> WHS</td> <td>White Gloss Smooth</td> </tr> <tr> <td> GTT</td> <td>Graphic Matte Textured</td> <td> WHT</td> <td>White Matte Textured</td> </tr> <tr> <td> LGS</td> <td>Light Grey Gloss Smooth</td> <td> CC</td> <td>Custom Color¹</td> </tr> </table> <p>¹Custom color subject to additional charges, minimum quantities and extended lead times. Consult representative. Custom color description: _____</p>	BLS	Black Gloss Smooth	LGT	Light Grey Matte Textured	BLT	Black Matte Textured	PSS	Platinum Silver Gloss Smooth	DBS	Dark Bronze Gloss Smooth	VGT	Verde Green Matte Textured	DBT	Dark Bronze Matte Textured	WHS	White Gloss Smooth	GTT	Graphic Matte Textured	WHT	White Matte Textured	LGS	Light Grey Gloss Smooth	CC	Custom Color ¹
BLS	Black Gloss Smooth	LGT	Light Grey Matte Textured																						
BLT	Black Matte Textured	PSS	Platinum Silver Gloss Smooth																						
DBS	Dark Bronze Gloss Smooth	VGT	Verde Green Matte Textured																						
DBT	Dark Bronze Matte Textured	WHS	White Gloss Smooth																						
GTT	Graphic Matte Textured	WHT	White Matte Textured																						
LGS	Light Grey Gloss Smooth	CC	Custom Color ¹																						
<p>Standard Era® Base Cover</p>	<p>The standard Era Base Cover is a heavy and durable cast aluminum component, configured in two halves for easy attachment after the pole is raised and set onto the anchor bolts.</p> <div style="display: flex; justify-content: space-around; align-items: center;"> <div style="text-align: center;">  <p>5" O.D. Poles</p> </div> <div style="text-align: center;">  <p>6" O.D. Poles</p> </div> </div>																								
<p>Standard Flat Pole Cap</p>	<p>The standard Flat Pole Cap is cast aluminum, secured by a single top screw activating an internal expansion clip.</p> <div style="display: flex; justify-content: space-around; align-items: center;"> <div style="text-align: center;">  <p>3.4" O.D. Poles</p> </div> <div style="text-align: center;">  <p>4" O.D. Poles</p> </div> </div>																								

Optional Features

Optional Decorative Base Cover
Cat. No. | **HBC1**

The Decorative Base Cover is constructed of heavy and durable cast aluminum, the base is supplied in two halves for easy attachment after the pole is raised and set onto the anchor bolts.

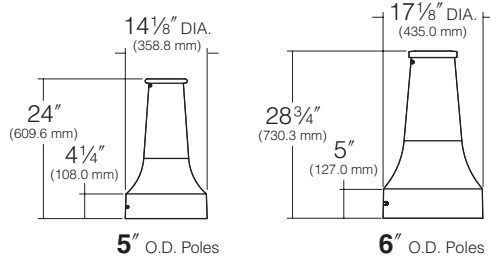

Optional Traditional Base Cover
Cat. No. | **HBC2**
| **No Option**

The Traditional Base Cover is constructed of heavy and durable cast aluminum, supplied in two halves for easy attachment after the pole is raised and set onto the anchor bolts.

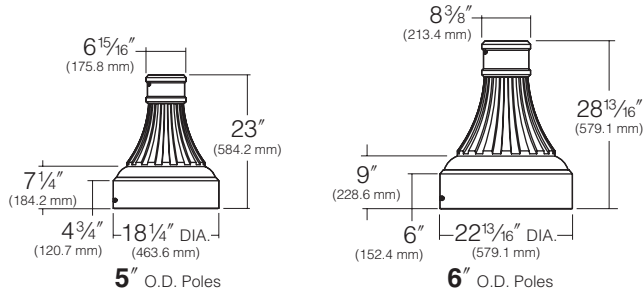

Optional Dome Pole Top Cap
Cat. No. | **HF1**

Dome Pole Top Cap is cast aluminum, finished to match the pole, and available for 3.4" and 4" diameter pole tops.

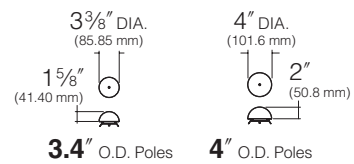

Optional Traditional Pole Top Finial
Cat. No. | **HF2**
| **No Option**

Each finial is cast aluminum, and available for 3.4" and 4" diameter pole tops.

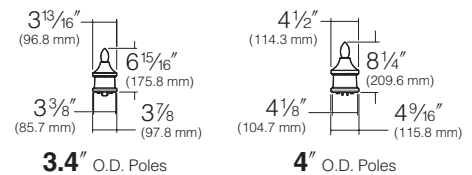

Optional Duplex Receptacle
Cat. No. | **DR**
| **DR-GFI**
| **No Option**

Mounted opposite the handhole, at 22-1/2" above the base cover, in a cast aluminum box that is internally welded and sealed with a gasketed self-closing cover and locking bracket.

Duplex Receptacle (DR) rated 20A., 125V.
Duplex Receptacle with Ground Fault Circuit Interrupter (DR-GFI) rated 20A., 125V.

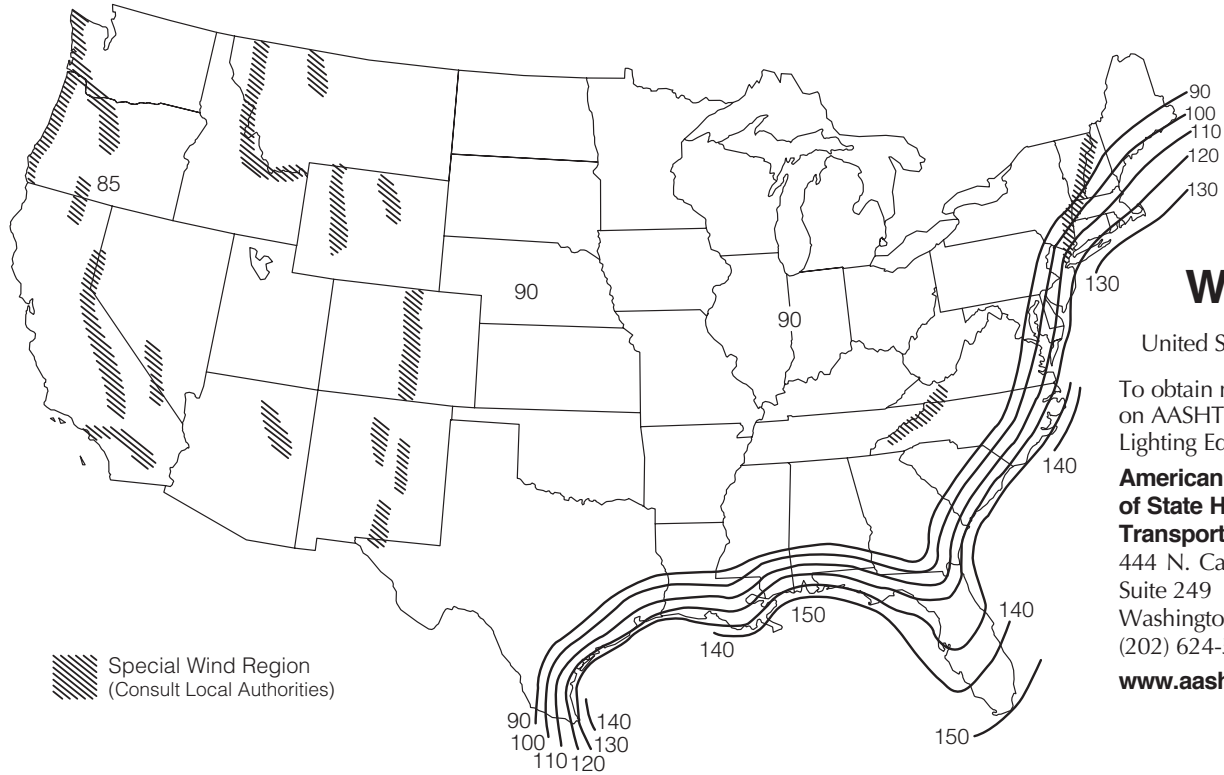

Wind Map

United States and Canada

To obtain more information on AASHTO Standards for Lighting Equipment contact:

American Association of State Highway and Transportation Officials:
 444 N. Capitol Street, NW,
 Suite 249
 Washington, DC 20001
 (202) 624-5800

www.aashto.org

NOTES:

- Values are based on 50 year mean recurrence interval 30' above grade.
- Hawaii has an **105 mph** wind velocity.
- Puerto Rico has a **125 mph** wind velocity.
- Caution must be exercised in determining wind velocities in special wind areas such as:
 - Mountainous Regions
 - Areas surrounding the Great Lakes or other large bodies of water or open land.
 - Areas subject to extreme wind conditions, such as hurricanes, typhoons, cyclones, and tornadoes.
 - Areas adjacent to airports.
 - Any specific area with a known or suspected abnormally high intermittent wind condition caused by geography, adjacent structures, or other specific local conditions that may not be recorded in National Weather Service records.
- Allowable pole EPA for jobsite wind conditions must be equal to or greater than fixture EPA. Responsibility lies with the specifier for correct pole selection based on AASHTO wind map and job location.

- The Wind Map is intended only as a general guide. Always consult local authorities to determine maximum wind velocities, gusting and unique wind conditions for each specific application.
- **CAUTION:** Wind speeds and listed EPAs are for ground mounted installations. Poles mounted on structures (such as bridges and buildings) must consider vibration and coefficient of height factors beyond this general guide. Consult AASHTO standards.
- Extreme Wind Events: Hurricanes, Typhoons, Cyclones, or Tornadoes expose poles to flying debris, wind shear, and other unpredictable aerodynamic forces not indicated by the wind velocity ratings.
- Pole Strength Limited Warranty: Standard, unmodified Kim lighting Poles installed as recommended, undamaged by corrosion, or lack of maintenance, shall withstand steady wind conditions as provided on page 2 (Allowable Pole EPA). Installation of poles without luminaires, or attachment of any unauthorized accessories to poles shall void this warranty.