

JOB _____

TYPE _____

NOTES _____

APPROVALS _____

FEATURES

- Die-cast copper aluminum with stainless steel fasteners
- 3000K CCT
- Aimable 358° vertically, horizontal aiming controlled by installation mounting device

CERTIFICATIONS



SPECIFICATIONS

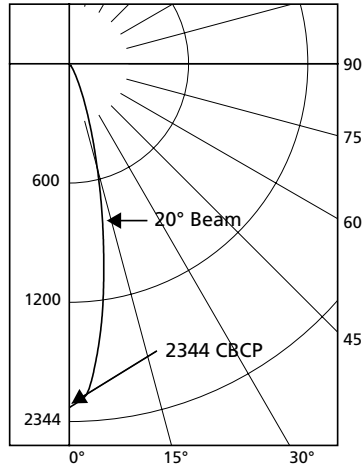
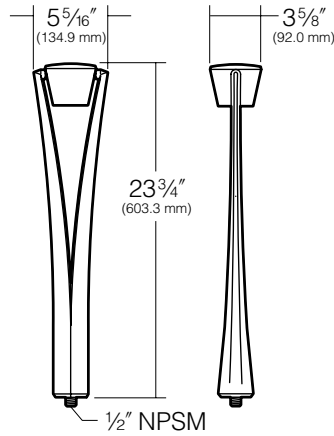

Voltage: 12 Watts: 6.84 Amps: 0.83
 Lumens: 470 CBCP: 2344 Beam: 20°
 CCT: 3000K Efficacy: 69 Lm/W

ORDERING CODE

Model	Fixture Options	Mounting Options
KLVL171BL ¹ Black KLVL171DB ¹ Dark Bronze KLVL171GR ¹ Verde Green	PL ² Prismatic Spread Lens softens lamp distribution. Best with spot. SL ² Linear Spread Lens creates oval beam pattern. Best with spot.	EP17 Landscape Light Post Mount, 12V & 120V KLV400 ³ Spear Mount, 12V JB1 ³ Architectural J-box, 12V & 120V JBR-2 In-grade J-box (2) 1/2" NPT in bottom, 12V & 120V JBR-3 In-grade J-box (2) 3/4" NPT in bottom, 12V & 120V JBR-4 Composite in-grade J-box (2) 1/2" NPT in bottom, (4) NPT on sides @ 90°, 12V & 120V JBR-5 Brass cover, composite in-grade J-box (2) 1/2" NPT in bottom, (4) NPT on sides @ 90°, 12V & 120V JBR-21 In-grade J-box (2) 1/2" NPT in sides, (2) 1/2" NPT in bottom, 12V & 120V JBR-24 In-grade J-box (4) 1/2" NPT in sides, (2) 1/2" NPT in bottom, 12V & 120V JBR-30 Brass in-grade staked J-box, 12V & 120V JBR-32 Brass in-grade staked J-box with cord, 120V SM18 ³ Stanchion Mount, 12V & 120V ³

¹ Remote transformer required.

² Inserts behind lens.

³ Specify finish, **BL** - Black, **DB** - Dark Bronze, **GR** - Verde Green.

Kim Lighting reserves the right to change specifications without notice.

LUMINAIRE PERFORMANCE

Nominal Lumen Package	Center Beam Candle Power	Watts	Lumens Per Watt
470	2344	6.84	69

SPECIFICATIONS

Lamp Housing:

- Die-cast low copper aluminum, stainless steel fasteners and stainless steel set screw lock for aiming pivot.

Aiming:

Aimable 358° vertically, horizontal aiming controlled by installation on mounting device.

Ravenna Yoke:

- Die-cast low copper aluminum, stainless steel fasteners and 1/2" NPSM brass nipple mount.

Lens:

- Tempered glass, 1/8" nominal thickness.

Gasketing:

- Silicone gaskets used throughout.

Transformer:

- Remote low voltage transformer required.

Wiring:

- 6' No. 18-2 12 volt cable with spade connectors for low voltage cable system connection.

Driver/Optical System:

- 3 LED emitters configured in a triangle array comprised together as a module. Each LED is encapsulated under a precision optical prism to produce a narrow flood pattern. The -40c driver is within the module and operates on 12V AC or DC current, 10 watt, 0.83 amp.

Finish:

- Fade and abrasion resistant, electrostatically applied, thermally cured, triglycidal isocyanurate (TGIC) polyester powder coat.
- Standard colors include (BL) Black, (DB) Dark Bronze, and (VG) Verde Green.

Certifications and Listings:

- UL 1598 Standard for wet locations for Luminaires.
- UL 8750 Standard for Safety for Light Emitting Diode (LED) Equipment for use in Lighting Products.

Caution:

- Fixtures must be grounded in accordance with national, state and/or local electrical codes, Failure to do so may result in serious personal injury.



Warranty:

- For full warranty see <http://www.hubbellighting.com/resources/warranty>

Kim Lighting reserves the right to change specifications without notice.

OPTIONS

Fixture Options:

- Prismatic Lens:** Softens lamp distribution and flattens beam spread. Best with flood lamps. Replaces standard lens. Cannot be used in combination with HL louver.
 
- Spread Lens:** Creates an oval beam pattern, more narrow in one beam axis. Best with spot lamps. Replaces standard lens. Cannot be used in combination with HL louver.
 

Mounting Options:

- Landscape Light Post:** PVC fixture molded in black with 1/2" NPT mount is corrosion free and UV resistant. Replaces EMT, conduit connectors and weatherproof boxes. 100% shatter resistant against denting and cracking. Angled bottom to eliminate cable congestion. 17 1/2" post length

Caution: The Ravenna Highlighter tray may be too heavy for the EP17. Any slight impact could damage the cap.

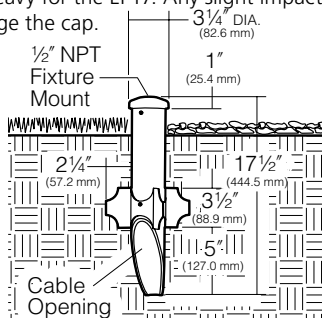

- Low Voltage Spear Mount:** Die-cast low copper aluminum with K" NPSM fixture mount. Stainless steel set screw locks fixture into mount. Cable slot allows easy fixture mounting before or after installation in ground. Super TGIC powder coat paint over clear anodizing and titanated zirconium conversion coating.

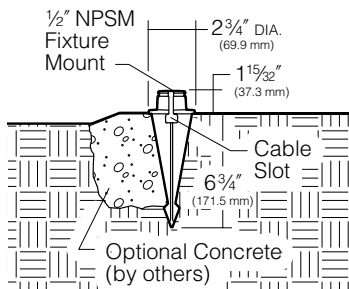

Architectural Junction Box

- Die-cast aluminum with 1/2" NPSM fixture mount. Internal set screw provided for locking position. Two 1/2" NPSM in bottom, 17 cu in. internal volume. Super TGIC powder coat paint over clear anodizing and titanated zirconium conversion coating.

Application Notes

- Elevates Accent Lights above ground cover to prevent foliage from blocking the light.
- Elevates Path Lights above ground cover to achieve a greater light throw.

CAUTION: Junction box must be installed high enough to avoid contact with soil or standing water.

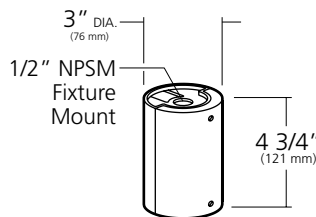

Brass In-grade Architectural Junction Box

- Die-cast brass with K" NPSM fixture mount and die-cast cover. Internal set screw provided for locking position. 18 cu in. internal volume.

JBR-2 (2) 1/2" NPT in bottom

JBR-3 (2) L" NPT in bottom

JBR-21 (2) 1/2" NPT in sides, (2) 1/2" NPT in bottom

JBR-24 (4) 1/2" NPT in sides, (2) 1/2" NPT in bottom

All side taps provided with plugs.

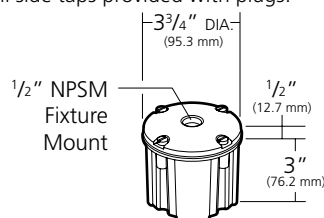

25 Year Limited Warranty:

Solid brass junction boxes are warranted for 25 years, from date of sale, against manufacturing defects and failure due to corrosion.

Application Notes

- Creates a flush-mounted appearance.
- May be cast in concrete for increased stability.

CAUTION: Fixture stem and swivel must not contact soil or standing water. Provide drainage away from junction box.

Composite In-Grade Architectural Junction Box

Composite box with 1/2" NPSM fixture mount and composite cover. 19 cu in. internal volume.

JBR-4 (2) L" NPT knockouts in bottom.

(4) L" NPT knockouts on sides.

JBR-5 Same as above but with brass cover.

CAUTION: Fixture stem and swivel must not contact soil or standing water. Provide drainage away from J-Box.

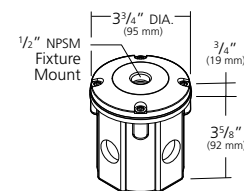

Stanchion Mount

3" O.D. by .188" wall cast aluminum with 1/2" NPSM fixture mount and hand hole with flush cover. Internal set screw fixture lock accessible through hand hole. Internal ground lug supplied with installed lead. Super TGIC powder coat paint over clear anodizing and titanated zirconium conversion coating.

