



## FEATURES

- Labor-saving pre-wired assembly; ready for installation
- Replaces outdated, non-efficient strip lighting with low wattage, high lumen solutions
- 60,000 hour LEDs at L80 for reduced maintenance
- Compact size with excellent light distribution and dimming options
- Safety tether standard on all models
- Two widths available to fit most 4-4.25" or 5-5.25" channels
- Available in 4' and 8' lengths
- Optional snap-on lens with endcaps can be factory or field-installed
- Occupancy and daylight sensors available for both lensed and unlensed versions
- Battery backup available for most configurations
- Five year warranty (Terms and Conditions Apply)

## PROJECT INFORMATION

Project Name \_\_\_\_\_

Type \_\_\_\_\_

Catalog No. \_\_\_\_\_

Date \_\_\_\_\_

## CONSTRUCTION

Housing plate manufactured from code gauge cold-rolled steel. Kit includes pre-wired LED engine assembly.

## SHIELDING

Optional frosted acrylic lens to eliminate pixelation. Easy to remove for access to LED module.

## FINISH

All reflective surfaces are finished after fabrication with unique formula high reflectivity white paint for soft, uniform indirect illumination.

## ELECTRICAL

Driver options include fixed output for on/off function, step dimming (high/low/off), or continuous 0-10V dimming. Available in 120-277V or 347V.

## STRIPLIGHT COMPATIBILITY

Minimum dimension requirements are listed below. **Columbia Lighting recommends a trial installation prior to ordering project quantities.** LSRK retrofit kits are designed to fit most 4.00-4.25" and 5.00-5.25" wide striplight channels.

## CERTIFICATION

All luminaires are built to UL1598 standards and bear appropriate CSA labels. Damp location labeling is standard. Emergency-equipped fixtures labeled UL 924.

## WARRANTY

Five year warranty (Terms and Conditions apply).

## ORDERING INFORMATION

## EXAMPLE LSRK4-5W-35LW-FA-EDU

LSRK		-		-		-		-		-	
MODEL	CHANNEL WIDTH	LUMEN OUTPUT	LENS	DRIVER	VOLTAGE	OPTIONS					
LSRK Linear Strip Retrofit Kit	4W 4.25" nominal 5W 5.00" nominal	XW Extra Low Watt <sup>1</sup> VW Very Low Watt <sup>1</sup> MW Medium Low Watt LW Low Watt ML Medium Lumen HL High Lumen <sup>4</sup> VL Very High Lumen <sup>4</sup> XL Extra High Lumen <sup>2,3</sup>	Blank No Lens FA Frosted Acrylic Lens with Endcaps	E Fixed Output ED 0-10V Dimming ED1 0-10V Dimming to 1% ESD Step Dimming DALIP DALI Power Bus <sup>5</sup>	U 120V-277V 347 347V <sup>6</sup>	ELL14 Emergency Battery Pack Installed, 1400 Lumens <sup>3,4,7</sup> LSP Lighting Surge Protector <sup>6,7,8</sup> GLR Fast Blow Fuse <sup>7</sup> GTD Generator Transfer Device <sup>7</sup> ZRE ControlScope <sup>®</sup> compatible <sup>9</sup> ODPG Occupancy and Daylight Sensors w/ Grouping, Philips SNS2009 <sup>10</sup>					
	SIZE	COLOR TEMP									
	4 4'	30 3000K									
	8 8'	35 3500K 40 4000K 50 5000K									

<sup>1</sup> 4ft XW, VX not offered with ESD drivers

<sup>2</sup> 8ft XL not offered with ESD, 347V, or Lutron drivers

<sup>3</sup> For XL package, battery backup not offered for ambient temps above 35°C

<sup>4</sup> For HL, VL package, battery backup not offered for ambient temps above 30°C

<sup>5</sup> DALIP only available when ODPG control option is selected

<sup>6</sup> Available with E, ED, or ED1 drivers only

<sup>7</sup> Not available in 347V

<sup>8</sup> Not available with ELL14 battery pack or GTD transfer device.

<sup>9</sup> Registered trademark of Daintree networks; used by permission.

<sup>10</sup> ODPG only available with DALIP driver option

## ACCESSORIES (ORDER SEPARATELY)

- OS1360K** Occupancy/Daylight Sensor, with 360° lens, 120/277
- OS1AK** Occupancy/Daylight Sensor, with aisle lens, 120/277
- LSRKFA4** 4' Frosted Acrylic Lens, field installed
- LSRKFAB** 8' Frosted Acrylic Lens, field installed
- LSRKEC** Lens Endcap, field installed
- LSRKJ** Joint piece for continuous row mounting

**PRODUCT AVAILABILITY**

Size	Color Temperature	Lumen Package	Lumens (with lens)	Watts	LPW
4ft	3000K	XW	2364	19.7	120.0
		VW	3066	26.7	114.8
		MW	3419	30.3	112.8
		LW	3996	32.8	121.8
		ML	4551	38.1	119.4
		HL	5262	45.5	115.6
		VL	6679	62.0	107.7
		XL	7601	68.6	110.8
	3500K	XW	2444	19.7	124.1
		VW	3170	26.7	118.7
		MW	3535	30.3	116.7
		LW	4132	32.8	126.0
		ML	4705	38.1	123.5
		HL	5440	45.5	119.6
		VL	6906	62	111.4
		XL	7859	68.6	114.6
	4000K	XW	2482	19.7	126.0
		VW	3219	26.7	120.6
		MW	3590	30.3	118.5
		LW	4196	32.8	127.9
		ML	4778	38.1	125.4
		HL	5525	45.5	121.4
		VL	7013	62	113.1
		XL	7981	68.6	116.3
	5000K	XW	2548	19.7	129.4
		VW	3305	26.7	123.8
		MW	3686	30.3	121.6
		LW	4308	32.8	131.3
		ML	4906	38.1	128.8
		HL	5672	45.5	124.7
		VL	7200	62	116.1
		XL	8194	68.6	119.4

**PRODUCT AVAILABILITY**

Size	Color Temperature	Lumen Package	Lumens (with lens)	Watts	LPW
8ft	3000K	XW	4728	39.4	120.0
		VW	6131	53.4	114.8
		MW	6838	60.6	112.8
		LW	7992	65.6	121.8
		ML	9101	76.2	119.4
		HL	10523	91	115.6
		VL	13558	124	109.3
		XL	15201	137.2	110.8
	3500K	XW	4889	39.4	124.1
		VW	6340	53.4	118.7
		MW	7071	60.6	116.7
		LW	8264	65.6	126.0
		ML	9411	76.2	123.5
		HL	10881	91	119.6
		VL	13812	124	111.4
		XL	15718	137.2	114.6
	4000K	XW	4964	39.4	126.0
		VW	6438	53.4	120.6
		MW	7180	60.6	118.5
		LW	8392	65.6	127.9
		ML	9556	76.2	125.4
		HL	11049	91	121.4
		VL	14026	124	113.1
		XL	15961	137.2	116.3
	5000K	XW	5097	39.4	129.4
		VW	6610	53.4	123.8
		MW	7372	60.6	121.6
		LW	8616	65.6	131.3
		ML	9811	76.2	128.8
		HL	11344	91	124.7
		VL	14400	124	116.1
		XL	16387	137.2	119.4

**PHOTOMETRIC DATA**

Test #17.00691 Test Date 3/22/2017

**LUMINAIRE DATA**

Luminaire	LSRK4-4W-30XW-FA-EDU Linear LED Retrofit Kit, Striplight 4" x 48" LED with gloss white channel cover with frosted acrylic lens
Ballast	XI020C056V054BST1
Ballast Factor	1.00
Lamp	LED
Fixture Lumens	2364
Watts	19.70
Mounting	Recessed
Shielding Angle	0° = 90 90° = 90
Spacing Criterion	0° = 1.17 90° = 1.25
Luminous Opening in Feet	Length: 4.00 Width: 0.25 Height: 0.08

**ZONAL LUMEN SUMMARY**

Zone	Lumens	% Lamp	% Fixt.
0-30	571	24.2	24.2
0-40	921	39.0	39.0
0-60	1592	67.3	67.3
0-90	2215	93.7	93.7
0-180	2364	100.0	100.0

**ENERGY DATA**

Total Luminaire Efficiency	100.0%
Total Lumens per Watt	120
IESNA RP-1-2004 Compliance	Non-Compliant
Comparative Yearly Lighting Energy Cost per 1000 Lumens	\$2.03 based on 3000 hrs. and \$0.08 per KWH

**INDOOR CANDELA PLOT**

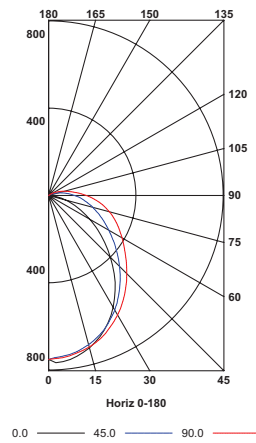

**PHOTOMETRIC DATA**

Test #17.00686 Test Date 3/21/2017

**LUMINAIRE DATA**

Luminaire	LSRK4-4W-30ML-FA-EDU Linear LED Retrofit Kit, Striplight 4" x 48" LED with gloss white channel cover with frosted acrylic lens
Ballast	XI040C110V054BST1
Ballast Factor	1.00
Lamp	LED
Fixture Lumens	4551
Watts	38.10
Mounting	Recessed
Shielding Angle	0° = 90 90° = 90
Spacing Criterion	0° = 1.17 90° = 1.25
Luminous Opening in Feet	Length: 4.00 Width: .025 Height: 0.08

**ZONAL LUMEN SUMMARY**

Zone	Lumens	% Lamp	% Fixt.
0-30	1099	24.2	24.2
0-40	1773	39.0	39.0
0-60	3063	67.3	67.3
0-90	4261	93.6	93.6
0-180	4551	100.0	100.0

**ENERGY DATA**

Total Luminaire Efficiency	100.0%
Total Lumens per Watt	119
IESNA RP-1-2004 Compliance	Non-Compliant
Comparative Yearly Lighting Energy Cost per 1000 Lumens	\$2.00 based on 3000 hrs. and \$0.08 per KWH

**INDOOR CANDELA PLOT**

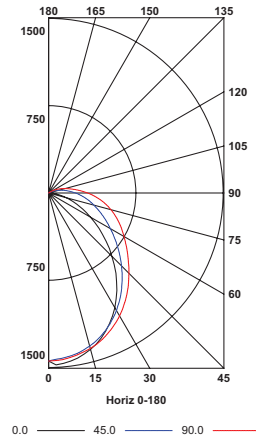

**PHOTOMETRIC DATA**

Test #17.00633 Test Date 3/13/2017

**LUMINAIRE DATA**

Luminaire	LSRK4-4W-30XL-FA-EDU Linear LED Retrofit Kit, Striplight 4" x 48" LED with gloss white channel cover with frosted acrylic lens
Ballast	XI040C110V054BST1
Ballast Factor	1.00
Lamp	LED
Fixture Lumens	7601
Watts	68.60
Mounting	Recessed
Shielding Angle	0° = 90 90° = 90
Spacing Criterion	0° = 1.17 90° = 1.25
Luminous Opening in Feet	Length: 4.00 Width: .025 Height: 0.08

**ZONAL LUMEN SUMMARY**

Zone	Lumens	% Lamp	% Fixt.
0-30	1836	24.2	24.2
0-40	2964	39.0	39.0
0-60	5123	67.4	67.4
0-90	7121	93.7	93.7
0-180	7601	100.0	100.0

**ENERGY DATA**

Total Luminaire Efficiency	100.0%
Total Lumens per Watt	111
IESNA RP-1-2004 Compliance	Non-Compliant
Comparative Yearly Lighting Energy Cost per 1000 Lumens	\$2.18 based on 3000 hrs. and \$0.08 per KWH

**INDOOR CANDELA PLOT**

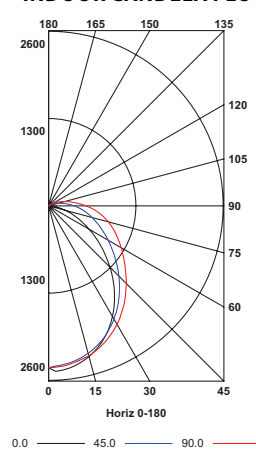

**PHOTOMETRIC DATA**

Test #17.00553 Test Date 2/16/2017

**LUMINAIRE DATA**

Luminaire	<b>LSRK4-4W-30XW-EDU</b> <b>Linear LED Retrofit Kit, Striplight</b> <b>4" x 48" LED with gloss white channel cover</b>
Ballast	<b>XI020C056V054BST1</b>
Ballast Factor	<b>1.00</b>
Lamp	<b>LED</b>
Fixture Lumens	<b>2527</b>
Watts	<b>19.70</b>
Mounting	<b>Recessed</b>
Shielding Angle	<b>0° = 90 90° = 90</b>
Spacing Criterion	<b>0° = 1.31 90° = 1.30</b>
Luminous Opening in Feet	<b>Length: 4.00</b> <b>Width: 0.21</b> <b>Height: 0.00</b>

**ZONAL LUMEN SUMMARY**

Zone	Lumens	% Lamp	% Fixt.
0-30	660	26.1	26.1
0-40	1092	43.2	43.2
0-60	1975	78.2	78.2
0-90	2527	100.0	100.0
0-180	2527	100.0	100.0

**ENERGY DATA**

Total Luminaire Efficiency	<b>100.0%</b>
Total Lumens per Watt	<b>128</b>
IESNA RP-1-2004 Compliance	<b>Non-Compliant</b>
Comparative Yearly Lighting Energy Cost per 1000 Lumens	<b>\$1.90 based on 3000 hrs. and \$0.08 per KWH</b>

**INDOOR CANDELA PLOT**

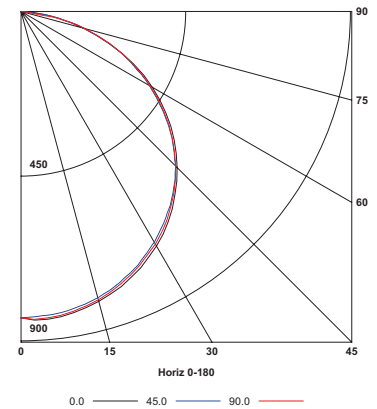

**PHOTOMETRIC DATA**

Test #17.00497 Test Date 2/15/2017

**LUMINAIRE DATA**

Luminaire	<b>LSRK4-4W-30XL-EDU</b> <b>Linear LED Retrofit Kit, Striplight</b> <b>4" x 48" LED with gloss white channel cover</b>
Ballast	<b>XI040C110V054BST1</b>
Ballast Factor	<b>1.00</b>
Lamp	<b>LED</b>
Fixture Lumens	<b>8276</b>
Watts	<b>69.00</b>
Mounting	<b>Recessed</b>
Shielding Angle	<b>0° = 90 90° = 90</b>
Spacing Criterion	<b>0° = 1.30 90° = 1.30</b>
Luminous Opening in Feet	<b>Length: 4.00</b> <b>Width: .021</b> <b>Height: 0.00</b>

**ZONAL LUMEN SUMMARY**

Zone	Lumens	% Lamp	% Fixt.
0-30	2161	26.1	26.1
0-40	3576	43.2	43.2
0-60	6467	78.1	78.1
0-90	8276	100.0	100.0
0-180	8276	100.0	100.0

**ENERGY DATA**

Total Luminaire Efficiency	<b>100.0%</b>
Total Lumens per Watt	<b>120</b>
IESNA RP-1-2004 Compliance	<b>Non-Compliant</b>
Comparative Yearly Lighting Energy Cost per 1000 Lumens	<b>\$2.00 based on 3000 hrs. and \$0.08 per KWH</b>

**INDOOR CANDELA PLOT**

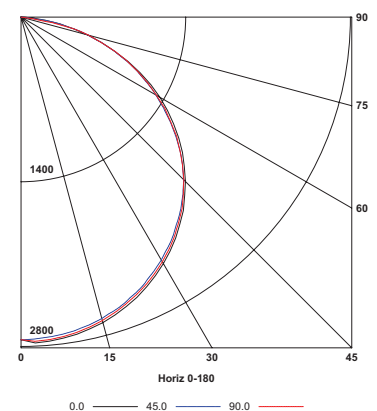

**DIMENSIONAL DATA**

Side View, 4'

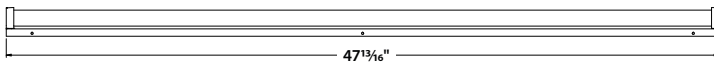

Side View, 8'

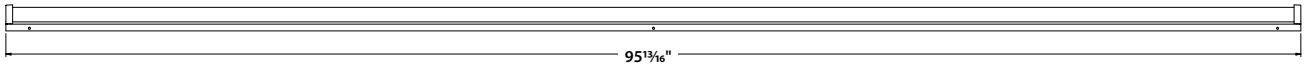

Cross Section, 4W

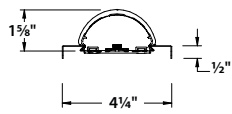

Cross Section, 5W

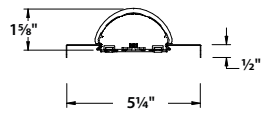

**SENSOR OPTIONS**

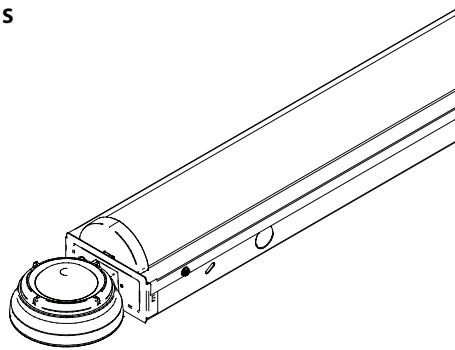

OS Sensor Option  
(field installed)